

Energy Research Program

Publishable Final Report

Program Control:

Climate and Energy Fund

Program Management:

Austrian Research Promotion Agency (FFG)

Final Report

created

06/07/2021

OptEnGrid

Optimal integration of heat, electricity and gas systems to increase efficiency and reliability

Project Number: 858815

Energy Research Program – 3rd Call

Climate and Energy Funds of the Federal Government - handled by the Austrian Research Promotion Agency (FFG)

Call	3 rd Call Energy Research Program
Project start	01/04/2017
Project end	31/03/2021
Total project duration (in months)	48 months
Project holder (institution)	BEST – Bioenergy and Sustainable Technologies GmbH
Contact partner	Ing. Michael Zellinger, MSc
Postal address	Gewerpepark Haag 3, 3250 Wieselburg-Land
Telephone number	+43 5 02378 9432
Fax	
E-mail	michael.zellinger@best-reseach.eu
Website	https://www.best-research.eu/

OptEnGrid

Final Report



Authors:

Armin Cosic (BEST)
Christian Oberbauer (BEST)
Liedtke Pascal (BEST)
Michael Stadler (BEST)
Michael Zellinger (BEST)
Muhammad Mansoor (BEST)
Bernhard Gerards (SOLID)
Hannes Poier (SOLID)
Manfred Steinlechner (World Direct)
Tarek Ayoub (World Direct)
Thomas Mühlmann (Stadtwärme Lienz)

1 Table of Contents

1	Table of Contents.....	4
2	Introduction.....	5
2.1	Energy Flow and System Optimization.....	5
2.2	Simulation v. Optimization.....	6
3	Presentation of Content.....	8
3.1	Modelling Framework.....	8
3.1.1	3-Day-Type Optimization Model.....	9
3.1.2	8760-Optimization Model.....	11
3.1.3	Objective Functions.....	11
3.1.4	DER Technologies.....	12
3.1.5	Piece-Wise Cost Functions (PWA).....	17
3.1.6	Land Use Parameters and Constraints.....	19
3.1.7	Energy Balance.....	21
3.2	Use Cases.....	23
3.2.1	TFZ Microgrid Use Case.....	25
3.2.2	Seasonal Solar Thermal and Heat Storage for a residential community in Lower Austria..	27
3.2.3	Hydrogen-TFZ Extension.....	31
3.2.4	Hydrogen- Innsbrucker Kommunalbetriebe IKB.....	35
3.2.5	Helsinki Energy System.....	38
3.2.6	Validation of the Solar Thermal Model.....	41
3.2.7	World Direct (WD)-Building.....	43
3.2.8	Boiler Pool.....	46
4	Results and Conclusions.....	50
5	Outlook and Recommendations.....	53
5.1	Renewable Energy Communities.....	53
5.2	Electric Vehicles and EV Charging Infrastructure.....	55
5.3	Multi-Year Optimization.....	56
5.4	Temperature Modelling in Heating Technologies.....	56
5.5	Land Use Parameters and Constraints.....	57
6	References.....	59
7	Contact Details.....	61

2 Introduction

OptEnGrid is a cross-sectoral multi-energy system optimization tool for the optimal planning and dispatch of the Distributed Energy Resource (DER) technologies in smart- and microgrids. The methodology of OptEnGrid considers an optimization model which is based on Mixed-Integer Linear Programming (MILP) framework. The following sub-sections provide more details about the energy flow and system optimization inside OptEnGrid and the choice of the optimization over simulation.

2.1 Energy Flow and System Optimization

The MILP modelling framework considers various DER technologies of the microgrid with economic, ecological and operational parameters, decision variables and constraints to fulfill load demands (Electricity, Heating, Cooling and Hydrogen etc.) by constructing two different objective functions. The objectives of the optimization problem can be minimization of total annual energy costs, minimization of total annual carbon dioxide emissions or both in multi-objective setting with different weightage. The mathematical optimization of OptEnGrid provides optimal investment of technology mixture in terms of capacities and operational dispatch by fulfilling the minimization of the objective function. The complexity of OptEnGrid to provide optimal technology mixture and full the energy balance can be demonstrated through Sankey diagram shown in Figure 1.

Energy Flow Optimization in a Microgrid

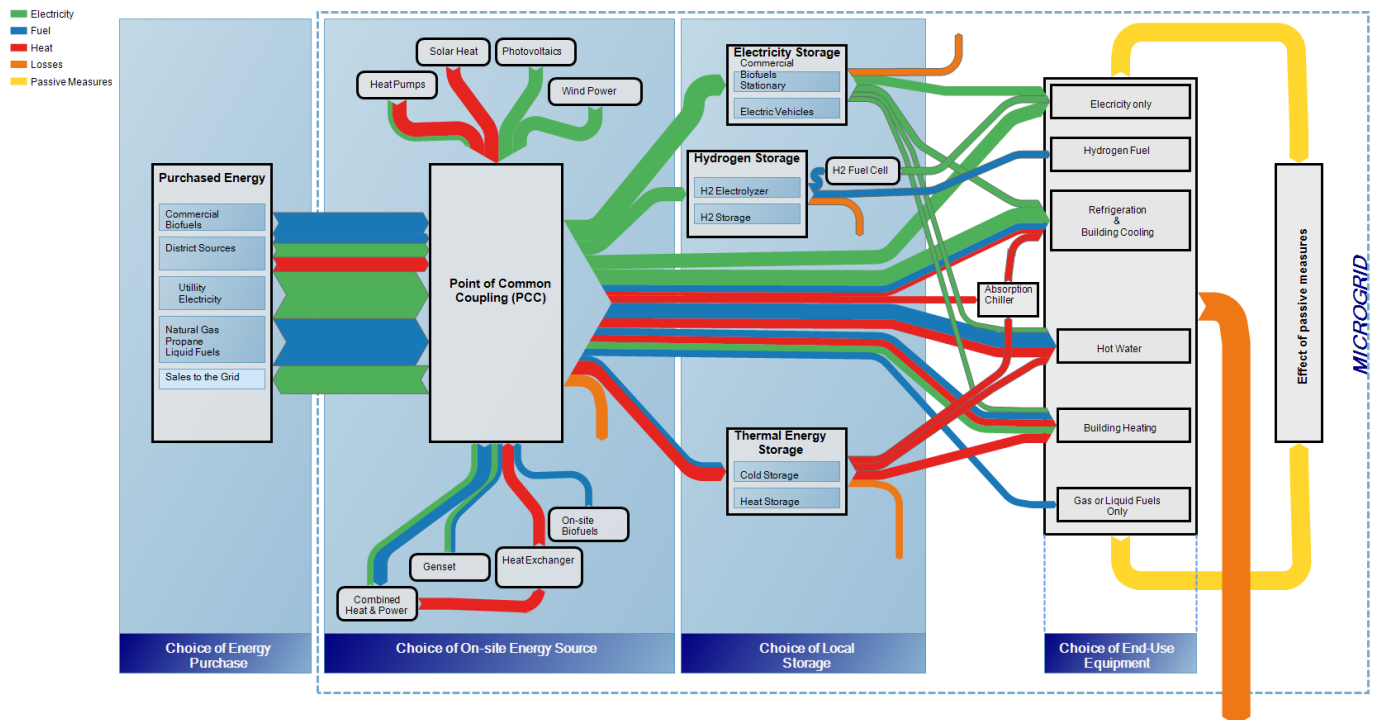

Figure 1: Sankey diagram of OptEnGrid tool showing energy flow from inputs to outputs in a microgrid.

Figure 1 shows the energy flow from different primary energy sources to the final load demands via different set of DER technologies in multi-energy system concept of a microgrid. The complexity lies in the

modelling of these DER technology taking input from various primary energy resources and interacting with high level energy balances in the cross-sectoral fashion to meet the load demands while taking into account numerous economic, ecological, operational constraints of the energy system in a microgrid.

2.2 Simulation v. Optimization

There are considerable differences between simulation and optimization approaches. Simulation and optimization are two different approaches and both have their own advantages and disadvantages, which make them suitable for certain types of problems and tasks.

Simulation allows us to understand the relationship between inputs (parameters/variables) and output of systems easily since a change in input data results directly in an output change. The user sets the input data. Each simulation activity is based on single iteration solution taking into account inputs that are either fixed inputs or have a range of available inputs to get output of the model. Simulation is mostly used for sensitivity analysis e.g. production line process model to simulate the different output of the production based on inputs such as no. of employees and raw material availability.

On other hand, Optimization allows us to find the true optimal solution of a complex systems based on certain boundaries and maximization or minimization criteria. Optimization uses mathematical feedback loop between output and inputs. Each optimization activity contains multiple iterative solution over certain criteria i.e. objective function and set of boundaries i.e. model constraints to give optimal solution of the system model. Optimization is used for the optimal system planning e.g. Planning of home energy system to get optimal renewable energy sources such as PV/Solar Thermal (Capacities and Operation Dispatch) to meet the load demand. Optimization models can use dedicated commercial solvers such as CPLEX, Gurobi etc. or free servers (weak performance mostly) which are based on different kinds of algorithms to obtain optimal solutions.

The major differences in using simulation and optimization can be provided in Table 1 below.

Table 1: Difference between simulation and optimization approaches for system modelling.

Simulation	Optimization
Simulation is better suited for “What-If Analysis” where system model can be observed in such a way that if different set of inputs are changed then what could be the output. This is also known as Sensitivity Analysis.	Optimization is better suited to determine the optimal design of the system model taking into account various input parameters, decision variables, system constraints and objective functions. Sensitivity analysis can also be done in optimization if more than one optimal solution has to be observed by changing input parameters, system constraints and mathematical framework of objective functions.
Simulation considers realistic values of inputs and step by step gradual modification with reasonable range to get different outputs.	Optimization considers defining the system boundaries i.e. constraints placed on various parameters and

Energy Research Program – 3rd Call

Climate and Energy Funds of the Federal Government - handled by the Austrian Research Promotion Agency (FFG)

	decision variables to get output of the objective functions.
Simulation can consider random variation in the parameters to improve accuracy of the system model.	Optimization considers clearly defined mathematical relationships through model equations that don't have any variability. However, uncertainty based optimization also exists.
Simulation is well suited for exploratory solutions of the system model	Optimization is well suited for best tactical and strategic planning decisions of the system model.
System models in a simulation environment are relatively easy to model and consume lower amount of computation power as compared to optimization based models.	System models based on optimization are relatively complex to model and consume higher computational power as compared to simulations based models.

A basic representation of an optimization model is also shown in Figure 2 where different relationships among input parameters, decision variables, system constraints and objective function based output of the model are shown.

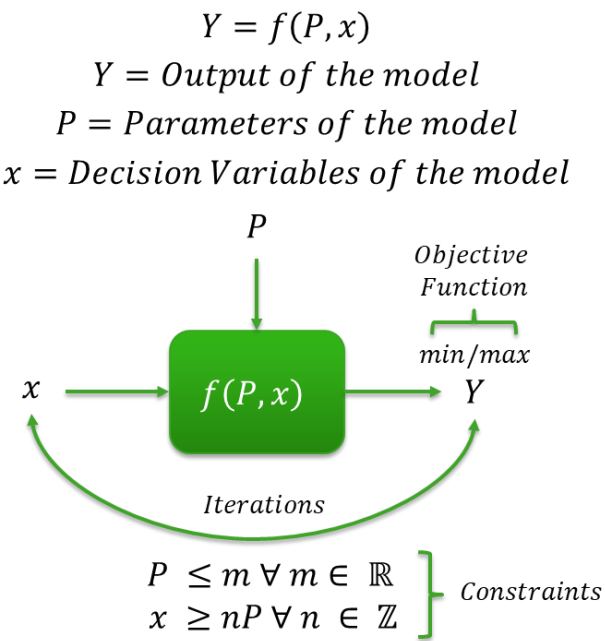

Figure 2: A basic representation of an optimization model of a system.

In a microgrid design with multi-energy system concept, the complexity is too high that only simulation based techniques can deal with that complexity and find an optimal system design in in a reasonable timeframe. Not only optimization provides optimal capacities of the various DER technologies of the microgrid but also provides optimal dispatch based on higher level energy balance in cross-sectoral configuration such as that shown in Figure 1. The operation dispatch of DER technologies is important to realize the optimal energy system behavior and schedule over time which is required in order to maintain the minimal total energy system costs and minimal carbon dioxide emissions. Therefore, OptEnGrid uses optimization to deal with the complexity and provide cutting edge capability of investment decision and operation dispatch in terms of optimal planning tool for multi-energy systems in microgrids.

3 Presentation of Content

This section includes the main modelling framework of the Mixed-Integer Linear Programming (MILP) methodology including the two major types of optimization model developed in OptEnGrid, the objective function details of the total annual energy costs and total annual carbon dioxide emissions, high-level energy balances of each energy sector i.e. electricity, heating and cooling, examples of different DER technologies with respect to modelling types, Piece-Wise Affine (PWA) cost function modelling for selected DER technologies, modelling of the land use parameters and constraints, and different use cases which are designed and optimally planned by using OptEnGrid tool.

3.1 Modelling Framework

The modelling framework of OptEnGrid considers the optimization model using MILP. The MILP framework balances the electrical, cooling and heating demands by services offered through optimized technology portfolio of Distributed Energy Resources (DERs) in a multi-energy system concept of microgrids. The MILP framework considers the multi-energy system of a microgrid or community either to be connected to the utility grid for electricity, heating and cooling or in island configuration. The modelling framework consider one or more than one node for solving the optimization problem. It is also possible to sell surplus energy to the utility grid.

Integer Programming (IP) and Mixed-Integer Programming (MIP) are special classes of Linear Programming (LP) that restrict all or some of the decision variables to integer values. Moreover, pure IP or MIP problems pose a great computational challenge. While highly efficient LP techniques exist to enumerate the basic LP problem at each possible combination of the discrete variables, the problem consists in the large number of combinations to be enumerated. The MILP solves the given problem by utilizing linear programming models that are based on integer and rational number values for decision variables. Also, the approximation of non-linear behavior by using the MILP approach increases the number of variables and constraints of the problem. Thus, a trade-off exists between the accuracy of the piecewise approximation and the computational burden of the final optimization problem. Furthermore, several modelling languages and commercial optimizers are available to solve complex optimization models. In the case of OptEnGrid, the code is written in the modelling language General Algebraic Modeling System (GAMS) and the commercial solver IBM/CPLEX is used to find the optimal solution of the microgrid system. However, also free solvers could be utilized.

The MILP minimizes the total annual energy costs and/or total annual carbon dioxide emissions as separate objective functions or in multi-objective setting. The total annual energy costs and the total annual carbon dioxide emissions are minimized over a typical year. The MILP framework is split into two different models having different time resolutions. The first model is called as 3-Day-Type Optimization model (see sub-section 3.1.1) and other one is called as 8760-Optimization model (see sub-section 3.1.2).

The DER technologies are modelled using continuous or discrete variables in the MILP framework. If a technology is available in small enough modules and the capital costs can be represented by a linear cost function or piecewise affine cost functions, the optimal capacity to be installed is modelled as a continuous

variable. These technologies are referred as continuous technologies in OptEnGrid. Examples of continuous technologies are PV, electric battery storage, hydrogen storage and absorption chiller. If a technology is available in specific unit capacities with specific dimensions commercially, it is modelled using discrete variables. These technologies are referred as discrete technologies in OptEnGrid. Example of discrete technologies are wind power, combined heat and power units, internal combustion engines and fuel cells.

The following mathematical framework considers the common index of *time* for the time resolution of the optimization model. The *time* index can be referred either to 3-Day-Type Optimization model or to 8760-Optimization model depending upon the time resolution used to perform the optimization. These two different models are described in details with respect to *time* index and their advantages and disadvantages in following sub-sections.

3.1.1 3-Day-Type Optimization Model

The 3-Day-Type optimization model uses time series aggregation to reduce the yearly data into 24-hour based three representative daytypes for each month using monthly peak preservation method [1]. The daytypes include weekday, peak and weekend representative profiles for each month.

The choice of these three different daytypes in each month is considered because the electrical, heating and cooling loads have variation in the consumption pattern within weekdays and weekend days of each month. The peak profiles are generated by taking the maximum of demand in every hour of all days in the month. The weekday and weekend profiles are then generated by subtracting the peak demand value in the hour of weekdays and weekend where that maximum occurred. Finally, all the load values of weekdays and weekends are averaged in each month to get weekday and weekend day profiles. Therefore, a typical year is modelled with the time resolution having hours $h \in \{1, 2, \dots, 24\}$, daytypes $d \in \{1, 2, 3\}$ and months $m \in \{1, 2, \dots, 12\}$. The total time resolution for the 3-Daytype optimization model is $12 \times 3 \times 24 = 864$ -hour time-steps instead of total 8760-hour time-step in a year.

The main advantage of the 3-Day-Type optimization model is the reduction in computational time while solving the optimization problem as compared to full year time series optimization. The main disadvantage of the 3-Day-Type model is that the energy cannot be stored seasonally in storage technologies such as heat storage, electric storage and hydrogen storage. It is because of the missing connectivity linkage between the time-steps of the representative profiles. Also, the variation of the renewable energy sources such as wind and PV cannot be captured completely using the 3-Daytype optimization model.

The electric load profiles for peak days, week days and weekend days are shown in the Figure 3 as an example for 3-Day-Type optimization model.

Energy Research Program – 3rd Call

Climate and Energy Funds of the Federal Government - handled by the Austrian Research Promotion Agency (FFG)

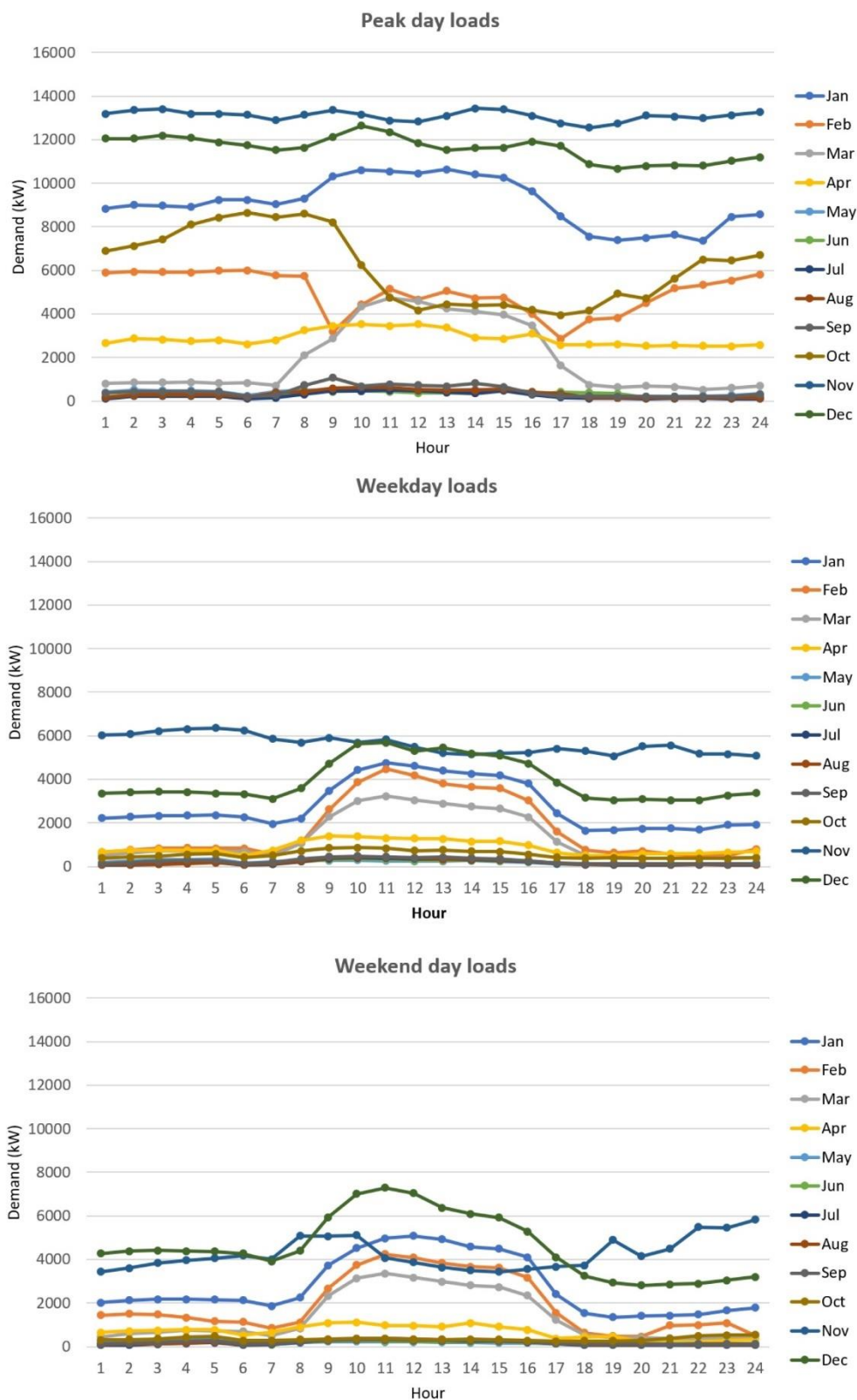

Figure 3: Example of load demand for 3-DayType optimization model in OptEnGrid.

3.1.2 8760-Optimization Model

The 3-Day-Type model does not consider the connectivity between the days and seasons of a year and can model the seasonal storage. Therefore, it can be required to consider the full-scale yearly time horizon of 8760-hours in the optimization. The time resolution of the MILP model is increased from 864 hours to 8760 hours by replacing the $h \in \{1, 2, \dots, 24\}$, daytypes $d \in \{1, 2, 3\}$ and months $m \in \{1, 2, \dots, 12\}$ with $t \in \{1, 2, \dots, 8760\}$ for all the loads and input data.

The main motivation is to capture the energy from renewable sources in summer months and use it in winter months via seasonal storage technologies. A major disadvantage of the 8760-Optimization model is that the computational time is extremely longer as compared to 3-Day-Type model while solving the optimization problem.

The electric load profile for the whole year is shown in the Figure 4 as example for 8760-Optimization model.

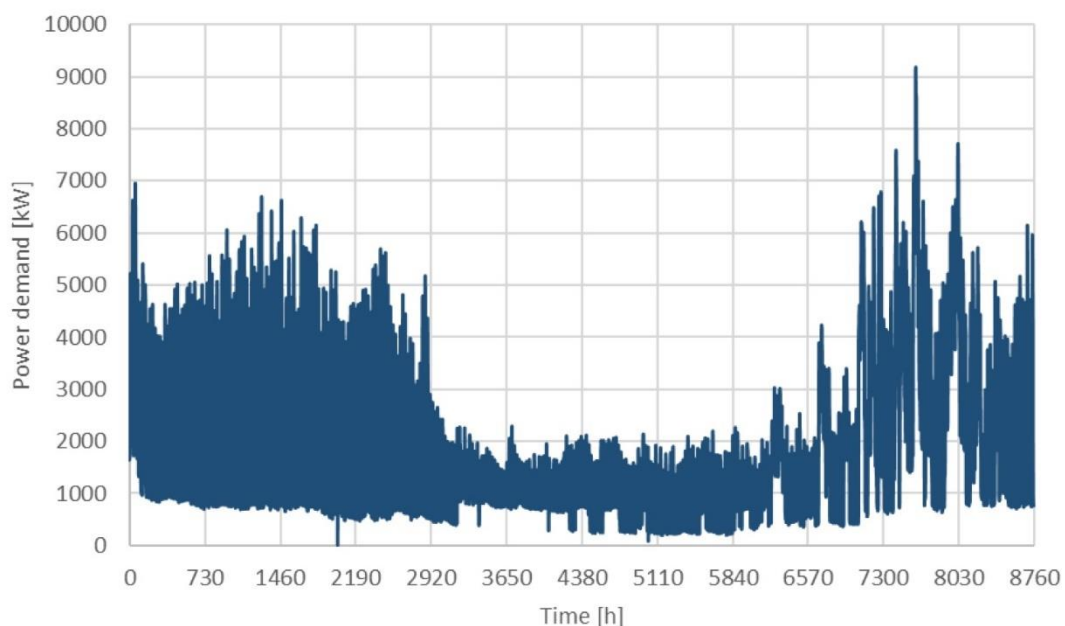

Figure 4: Example of load demand for 8760-optimization model in OptEnGrid.

3.1.3 Objective Functions

The Objective functions of the MILP optimization framework in OptEnGrid consists of three types:

1. Total Annual Energy Costs
2. Total Annual Carbon Dioxide Emissions
3. Multi-Objective in weightage of both Total Annual Energy Costs and Total Annual Carbon Emissions

Moreover, there is also possibility to limit the each objective function by respective reference case or basecase values of costs and carbon dioxide emissions of the energy system. The simplified objective function related to the total annual energy costs C can be represented by eq. (1).

$$C = \sum_{nodes,tech} DER_{invest} + \sum_{nodes,time} C_{O\&M} + \sum_{nodes,time} C_{utility} \quad (1)$$

Where DER_{invest} is the annualized investment cost of DER technologies, $C_{O\&M}$ is related to the operation and maintenance costs and $C_{utility}$ is related to the purchase minus sales to the utility grid for and other fixed costs related to utility such as fuel costs, time-of-use tariffs and daily and monthly demand charges etc. The index $nodes$ represents the actual location of end-user demands where DER technologies are to be invested. The microgrid modelling in OptEnGrid can consider 20 different $nodes$ at a single time for optimization and each node can represent a single microgrid based energy system and cluster of multiple nodes can also be used to represent a single microgrid energy system.

The investment optimization can be performed relative to a basecase/reference case scenario. Therefore, the total annual energy costs C are limited in the optimization by the costs of the reference case. This constraint is given in eq. (2).

$$C \leq C_{reference} \quad (2)$$

The simplified objective function related to the total annual carbon dioxide emissions CO_2 can be represented by eq. (3).

$$CO_2 = \sum_{nodes,time} CO_{2grid} + \sum_{fueltype,nodes,time} CO_{2fuels} \quad (3)$$

Where CO_{2grid} is the carbon footprint associated with the electricity purchase from the utility grid and CO_{2fuels} is the carbon footprint associated with the fuel (diesel, oil and biomass etc.) for continuous and discrete technologies. Similar to the cost limitation relative to reference case, the total annual carbon emissions are limited in the optimization by the carbon emissions of the reference case. This constraint is given in eq. (4).

$$CO_2 \leq CO_{2reference} \quad (4)$$

The multi-objective function is modelled by using two weightage parameters which combines the effect of two individual objectives e.g. a weightage of 60 for costs and a weightage of 40 for carbon dioxide emissions will consider the minimization of both total annual energy costs and total annual carbon dioxide emission by the scaling factor 60% and 40% respectively in multi-objective setting.

3.1.4 DER Technologies

The DER technologies in OptEnGrid are modelled as either continuous or discrete type. The continuous type technologies are modelled via continuous decision variables which decides the capacity and operational dispatch. The Table 2 provides details of which DER technologies are modelled in continuous and discrete types in OptEnGrid.

Energy Research Program – 3rd Call

Climate and Energy Funds of the Federal Government - handled by the Austrian Research Promotion Agency (FFG)

Table 2: DER technologies modelled in OptEnGrid as continuous and discrete variable types.

Technology	Continuous Variable Type	Discrete Variable Type
Solar PV	✓	
Solar Thermal	✓	
Wind Power		✓
Power-to-Heat	✓	
Power-to-Gas	✓	
Hydrogen Electrolyzer	✓	
Electric Storage	✓	
Heat Storage	✓	
Cold Storage	✓	
Hydrogen Storage	✓	
Flow Battery Energy	✓	
Flow Battery Power	✓	
Fuel Cells		✓
Electric Vehicles	✓	
Absorption Chiller	✓	
Absorption Refrigeration	✓	
Absorption Heat Pump	✓	
Air Source Heat Pump	✓	
Ground Source Heat Pump	✓	
Combined Heat and Power (CHP)		✓
Internal Combustion Engine (ICE)		✓
Central Heating	✓	
Central Super-Heating	✓	
Central Cooling	✓	
Central Refrigeration	✓	

The simplified mathematical modelling of the cost function of these continuous technologies is given as follows.

The DER_{invest} for continuous and discrete technologies is given by eq. (5).

$$DER_{Invest} = \sum_{tech} (C_{up_{tech}} \cdot \pi_{tech}) \quad (5)$$

Where $C_{up_{tech}}$ are the upfront capital (*up*) costs of the technology and π_{tech} is the annuity rate of the technology calculated over the lifetime of the technology.

The $C_{up\ tech}$ are further modelled in different ways for continuous technologies and discrete technologies. The $C_{up\ Cont\ Tech}$ for continuous technologies such as solar PV, solar thermal, battery storage, central heating etc. are modelled by using eq. (6).

$$C_{up\ Cont\ Tech} = VarC_{Cont\ Tech} \cdot Cap_{Cont\ Tech} + FixC_{Cont\ Tech} \cdot \delta_{Cont\ Tech} \quad (6)$$

Where $VarC_{Cont\ Tech}$ are the variable capital costs of the technology, $Cap_{Cont\ Tech}$ is the capacity of the technology to be invested, $FixC_{Cont\ Tech}$ are the fixed capital costs of the technology and $\delta_{Cont\ Tech}$ is the binary variable associated with the investment decision of technology. The variable capital costs vary with the amount of capacity that is invested, while the fixed capital costs are independent on the size of the technology and can cover engineering costs.

The $C_{up\ Disc\ Tech}$ for discrete technologies such as CHP units, ICE turbines and fuel cells etc. is given by eq. (7).

$$C_{up\ Disc\ Tech} = \alpha_{Disc\ Tech} \cdot MaxP_{Disc\ Tech} \cdot C_{Disc\ Tech} \quad (7)$$

Where $\alpha_{Disc\ Tech}$ is the integer decision variable which defines the number of the discrete technology units to be invested, $MaxP_{Disc\ Tech}$ is the numberplate capacity rating of the discrete technology per unit and $C_{Disc\ Tech}$ are the capital costs of the discrete technology per unit. This modelling is different from the continuous technologies because of the discrete integer decision variable $\alpha_{Disc\ Tech}$ and due to the fact that these kinds of technologies are available in specific sizes commercially so it is logical to model them in discrete function rather than continuous function.

The $C_{up\ Wind\ Tech}$ for wind power technology are modelled as discrete but there is minor difference in its model that consider the $C_{Wind\ Tech}$ per unit of wind turbine i.e. the these costs are not per kW but are per unit of the wind turbine. The upfront capital costs for wind power technology are given by eq. (8).

$$C_{up\ Wind\ Tech} = \beta_{Wind\ Tech} \cdot C_{Wind\ Tech} \quad (8)$$

Where $\beta_{Wind\ Tech}$ is the integer decision variable which defines the number of wind power technologies to be invested and $C_{Wind\ Tech}$ is the total unit costs of the wind turbine unit.

Certain technologies such as solar thermal, heat storage and absorption chiller also consider the modelling of their upfront capital costs by using Piece-Wise Affine (PWA) approach which is given in details in sub-section 3.1.5.

The O&M costs are the costs associated with yearly operation and maintenance costs that are not included in the capital investment but are the running costs after the technology is invested. A model example of O&M costs for continuous technologies is given by eq. (9).

$$O\&M_{Cont\ Tech,time} = C_{O\&M_{Cont\ Tech,time}} \cdot Cap_{Cont\ Tech} \quad (9)$$

Where $O\&M_{Cont\ Tech,time}$ is the running operation and maintenance costs of the continuous technology which depend upon the cost factor $C_{O\&M_{Cont\ Tech,time}}$ multiplied with the capacity of the continuous technology.

The utility costs contain the costs associated with using electricity from the grid and the cost of fuels associated with the fuel consumption etc. The summarized example of model equations related to the fuel costs that are incurred due to the use of fuel consumption in central heating is provided by eq. (10).

$$C_{fuelsforheat} = \sum_{fueltype,time} (FC_{fueltype,time} \cdot \mu_{fueltype,time}) \quad (10)$$

Where $C_{fuelsforheat}$ is the cost of fuels for central heating, $FC_{fueltype,time}$ is the fuel consumption per fuel type (biomass, biodiesel and gas etc.) and $\mu_{fueltype,time}$ is the fuel price per fuel type.

Modelling examples of few DER technologies such as solar thermal, heat storage and CHP units are provided below.

3.1.4.1 Solar Thermal Model

There are two different models for solar thermal in OptEnGrid. The first model is based on the solar thermal irradiance and solar thermal efficiency and the second model is based on the solar thermal performance. In the first model, the heat received from the solar thermal is the product of the solar thermal area, solar irradiance and solar thermal efficiency. It is given by eq. (11-12).

$$H_{time}^{Sth} = A^{Sth} \cdot I_{time} \cdot \eta_{time}^{Sth} \quad (11)$$

$$A^{Sth} = \frac{Cap_{Sth}}{S_{thout}^{peak}} \quad (12)$$

Where H_{time}^{Sth} is the heat received from the solar thermal, A^{Sth} is the decision variable for the solar thermal area, I_{time} is the parameter for solar thermal irradiance [2], η_{time}^{Sth} is the parameter for the solar thermal efficiency [3], Cap_{Sth} is the capacity variable of solar thermal and S_{thout}^{peak} is the peak output per area of the solar thermal.

The second model of the solar thermal is the product of the solar thermal capacity variable with the solar thermal performance parameter over time. It is given by the eq. (13).

$$H_{time}^{Sth} = Cap_{Sth} \cdot S_{thtime}^{performance} \quad (13)$$

Where $S_{th\,time}^{performance}$ is the parameter for the solar thermal performance over time. The solar thermal performance over time can either be retrieved data sources as Meteororm [4] and Renewable Ninja [5] or measured data of already installed solar thermal plants can be used. The difference between the first model and the second model is that the second model eliminates the need of calculating the solar thermal output by using irradiance and solar thermal efficiency parameters and directly consider the solar thermal performance of a specific location based on calculated physical conditions. The solar thermal area A^{St} in second model is calculated is the same ways as it is calculated in eq. (12) of first model.

3.1.4.2 Heat Storage Model

The heat storage model is defined by eq. (14-20).

$$H_{time}^{stored} = H_{time-1}^{stored} + H_{time}^{in} - H_{time}^{out} - H_{time}^{loss} \quad (14)$$

$$H_{time}^{in} = H_{time}^{for} \cdot \eta_{char} \quad (15)$$

$$H_{time}^{out} = H_{time}^{from} \cdot 1/\eta_{dis} \quad (16)$$

$$H_{time}^{loss} = H_{time-1}^{stored} \cdot \theta_s + Cap_{HS} \cdot \theta_{st} \cdot \frac{(T_{min} - T_{time}^{amb})}{(T_{max} - T_{min})} \quad (17)$$

$$H_{time}^{stored} \leq Cap_{HS} \quad (18)$$

$$H_{time}^{in} \leq Cap_{HS} \cdot \varphi_{char}^{max} \quad (19)$$

$$H_{time}^{out} \leq Cap_{HS} \cdot \varphi_{dis}^{max} \quad (20)$$

Where H_{time}^{stored} is the state of the charge of the heat storage, H_{time}^{in} is the input for heat storage, H_{time}^{for} is the heat required for storing in the heat storage, η_{char} is the charging efficiency, H_{time}^{out} is the heat output from the heat storage, H_{time}^{from} is the heat required from the heat storage, η_{dis} is the discharging efficiency, H_{time}^{loss} is the heat lost in the heat storage during working and standby conditions, θ_s is the loss factor during storage operation, θ_{st} is the loss factor during storage standby condition, Cap_{HS} is the capacity of the heat storage, T_{min} is the minimum temperature level of the heat storage, T_{max} is the maximum temperature level of the heat storage, T_{time}^{amb} is the ambient temperature, φ_{char}^{max} is the maximum charge rate of the heat storage and φ_{dis}^{max} is the maximum discharge rate of the heat storage.

Depending upon the setting of T_{min} and T_{max} , heat storage model can be further classified into Low Temperature (LT) and High Temperature (HT) models. The temperature range for LT heat storage is usually set for $T_{min} = 45^\circ C$ and $T_{max} = 65^\circ C$. The temperature range for HT storage is usually set for $T_{min} = 75^\circ C$ and $T_{max} = 95^\circ C$.

3.1.4.3 Combined Heat and Power (CHP) Model

Combustion turbine or reciprocating engine CHP systems burn fuel (natural gas, oil, biomass etc.) to turn generators to produce electricity and use heat recovery devices to capture the heat from the turbine or engine. The output from CHP systems are twofold i.e. electrical and heat which can be utilized for providing to the electrical and heating loads at the same time. The CHP systems are modelled in OptEnGrid as discrete technologies in the form of units. The different categories of CHP systems in OptEnGrid contain Mechanical Turbine (MT) and Internal Combustion Engine (ICE).

The summarized model to obtain electrical output from CHP units is given by eq. (21).

$$E_{CHP_{time}}^{out} = F_{CHP_{time}} \cdot \eta_{CHP} \quad (21)$$

Where $E_{CHP_{time}}^{out}$ is the electrical output from the CHP unit, $F_{CHP_{time}}$ is the fuel required for the CHP unit and η_{CHP} is the efficiency of the CHP unit. The heat output from CHP unit is given by eq. (22).

$$H_{CHP_{time}}^{out} = E_{CHP_{time}}^{out} \cdot \alpha_{CHP} \quad (22)$$

Where $H_{CHP_{time}}^{out}$ is the heat output from the CHP unit and α_{CHP} is the heat conversion efficiency of the CHP unit. The $E_{CHP_{time}}^{out}$ is further constrained by the maximum power rating of each CHP unit type and ultimately decides how many number of CHP units to be invested.

Research works that are already published [6, 7] in the dissemination of this project can be utilized for more detailed modelling steps including the technical data of DER technologies such as solar PV, wind power, solar thermal, heat storage, hydrogen electrolyzer and fuel cell electric vehicles.

3.1.5 Piece-Wise Cost Functions (PWA)

The cost functions of the technologies that are used in thermal and cooling systems such as solar thermal, heat storage and absorption chillers are not linear functions. The costs of large hot water heat storage systems are dominated by the material for the tank since the storage capacity is proportional to the volume of the tank. A simple dimensional analysis demonstrates that for the most common type of heat storages (hot water tanks), an approximate power-law can be used when comparing typical costs for storage tanks [8]. Similarly, the costs of large solar thermal systems [9] are observing non-linearities with its capacity and can be represented the same type of power law as for heat storage. This approximate power law is represented by eq. (23).

$$C_{up}(x) = A \cdot x^\alpha \quad (23)$$

Where $C_{up}(x)$ is the non-linear cost function of the technology, x is the capacity of the technology, A and α are the technology specific parameters (e.g. $A = 0.661$ [Million-EUR/MW] and $\alpha = 0.835$ for solar thermal [9] and $A = 141$ [EUR/kWh] and $\alpha = 0.667$ for heat storage [8]).

In order to linearize this non-linear behavior and use mixed-integer linear programming framework of the optimization modelling, the non-linear cost function is converted into piece-wise affine (PWA) linear approximations. An illustration of the PWA approximation function with three linear pieces over a non-linear cost function similar to eq. (23) is given in the Figure 5.

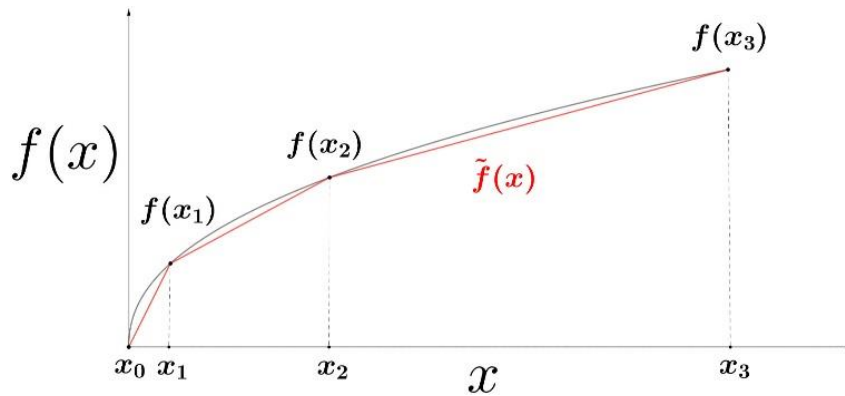

Figure 5: A schematic illustration of the PWA approximation function with three linear pieces.

The detailed modelling of PWA cost functions using convex combination model and subsequent fitting over non-linear cost function for heat storage and solar thermal is provided in the research work already published in the OptEnGrid (See Ref. [6]). The resulting PWA cost functions for solar thermal and heat storage technologies are provided in the Figure 6 and Figure 7 respectively.

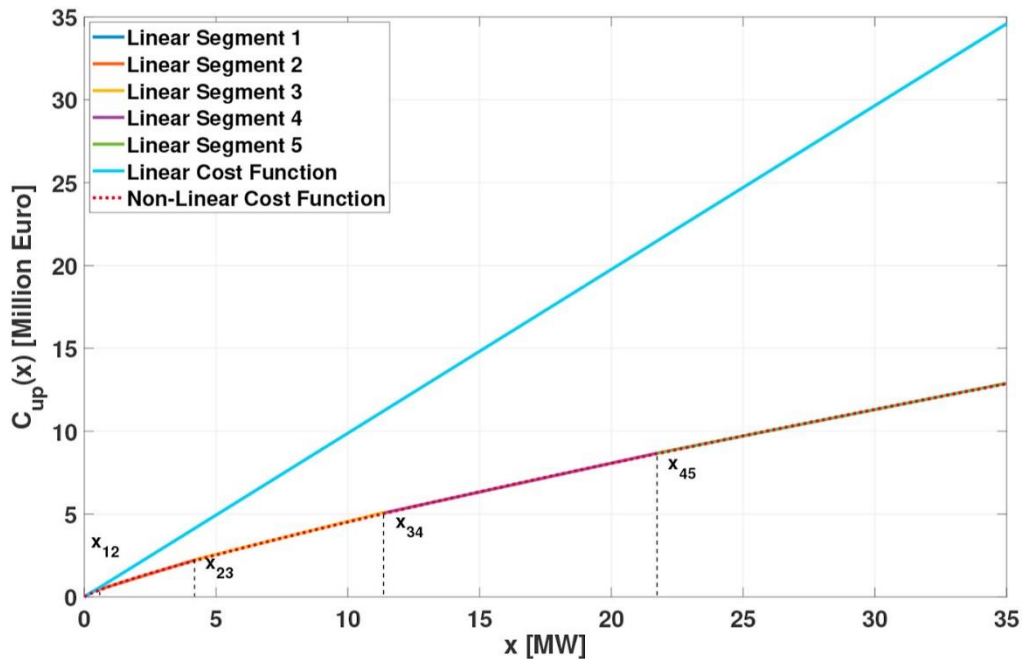

Figure 6: Cost vs. Capacity curve of solar thermal technology using linear, non-linear and PWA cost functions.

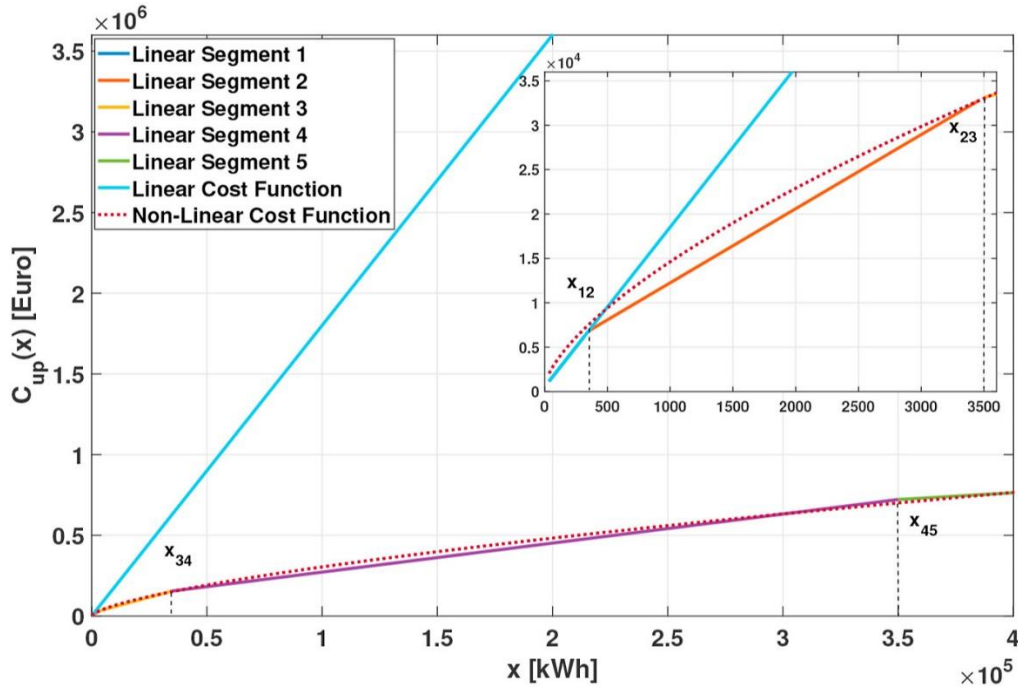

Figure 7: Cost vs. Capacity curve of heat storage technology using linear, non-linear and PWA cost functions.

It can be seen from above figures that using just the single linear cost function for these technologies can result in inaccurate planning and with the use of PWA cost functions in the MILP, more accurate planning strategies can be realized as compared to non-PWA cost function.

3.1.6 Land Use Parameters and Constraints

The main aim of adding land use parameters and constraints in the OptEnGrid model is to introduce the space used by building stocks (both residential and non-residential) and also different DER technologies (both continuous and discrete). The building stock options are considered in terms of residential and non-residential buildings with respect to their area. The capital investment costs per area and operation and maintenance costs per area of these building stocks are taken into account and then annualized over their lifetime. These annualized capital costs are given by eq. (24).

$$C_{build.stock\ Invest} = \sum_{build.stock.option} (C_{up\ build.stock.option} \cdot \pi_{build.stock.option}) \quad (24)$$

Where $C_{up\ build.stock.option}$ is the upfront capital costs of the building stock option and $\pi_{build.stock.option}$ is the annuity rate of the building stock option. The upfront capital cost of these building stocks is given by eq. (25).

$$C_{up\ build.stock.option} = VarC_{build.stock.option} \cdot Area_{build.stock.option} \cdot \lambda_{area.build.stock.option} \quad (25)$$

Where $VarC_{build.stock.option}$ is the per unit area capital costs of the building stock option, $Area_{build.stock.option}$ is the area of the building stock and $\lambda_{area.build.stock.option}$ is the binary variable associated with the invest option of the building stock. These annualized costs of building stock options

are then added to the overall objective function. There is also an operation and maintenance costs component of building stock options that depend upon the land use costs in running time (over a year) and it is also added to the overall objective function.

The area of the building stock options is constrained by the total area limit per node available for the building investment. This constraint is given by eq. (26).

$$Area_{build.stock.option} \leq Area_{limit_{node}} \quad (26)$$

The land use cost component for the DER technologies (both continuous and discrete) contain the costs associated with the area use of each technology type. It is also annualized over the lifetime of the technology and can be modelled as given in the following eq. (27-28).

$$DER_{Area} = \sum_{tech} (C_{up.Area_{tech}} \cdot \pi_{tech}) \cdot \Gamma_{tech} \quad (27)$$

$$C_{up.Area_{tech}} = Cap_{tech} \cdot Area_{tech} \cdot \rho_{area.tech} \quad (28)$$

Where $C_{up.Area_{tech}}$ are the upfront costs associated with the land use of DER technology, $Area_{tech}$ is the area of the DER technology per kWh or kW depending on the technology, $\rho_{area.tech}$ is the per unit area costs of the DER technology and Γ_{tech} is the binary parameter associated with “within building area” choice for Der technology. If the DER technology is considered within building then $\Gamma_{tech} = 0$ such as solar PV is considered to be on the roof-top of the building then the costs associated with land use of DER technology would be zero and only costs associated with the land use of the building will be taken into account. On the contrary, $\Gamma_{tech} = 1$ then the costs associated with the land use of DER are considered together with costs associated with the land use of building. The area of DER technology can also be constrained by the total area availability per technology type and also this total area availability of DER technologies can also be constrained by the total area of the building stock option if the DER technology is selected as within the area of the building (Γ_{tech} binary parameter) as give in eq. (29-30).

$$Area_{tech} \leq Area_{availability_{tech}} \quad (29)$$

$$\sum_{tech} (Area_{availability_{tech}} \cdot \Gamma_{tech}) \leq Area_{build.stock.option} \quad (30)$$

The costs associated with the land use of primary fuels such as biomass, biodiesel and gasoline etc. can also be considered in the modelling. These costs depend upon the amount of fuel used and the per unit area occupation of the fuel type multiplied with the per unit costs of the area of land dedicated to the storage of these fuels. These costs can be modelled as given in eq. (31).

$$C_{area\ fuels} = \sum_{fueltype} (FC_{fueltype} \cdot Area_{fueltype} \cdot \psi_{area.fueltype}) \cdot \Gamma_{fueltype} \quad (31)$$

Where $C_{area\ fuels}$ are the costs associated with the land use of fuels, $FC_{fueltype}$ is fuel consumption in kWh of energy content per fuel type, $Area_{fueltype}$ is the per unit area of the fuels, $\psi_{area.fueltype}$ is per unit area costs of the fuels and $\Gamma_{fueltype}$ is the binary parameter to select if the fuel is considered to be stored within the building or not. In case of fuel is considered to be stored within the building area ($\Gamma_{fueltype} = 0$) then there will be no costs associated with land use of fuels and vice versa. The area of each fuel type can also be constrained by the area availability per fuel type as given in eq. (32-33).

$$Area_{fueltype} \leq Area_{availability\ fueltype} \quad (32)$$

$$\sum_{fueltype} (Area_{availability\ fueltype} \cdot \Gamma_{fueltype}) \leq Area_{build.stock.option} \quad (33)$$

These constraints imposes certain limits for the building stock options, DER technologies and fuel types so that optimal design of the microgrids can contain an additional layer of the modelling with respect to land use reality.

3.1.7 Energy Balance

The higher-level energy balance among DER technologies and end-user demands has to be satisfied for each time-step of the optimization to successfully get a feasible solution. This higher-level energy balance can be represented by eq. (34).

$$\sum_{nodes,time} E_{Provided} = \sum_{nodes,time} E_{Consumed} \quad (34)$$

Where $E_{Provided}$ is the energy provided by the continuous and discrete technologies and $E_{Consumed}$ is the energy used by the end-user demands. The end-user demands in OptEnGrid are further divided into 8 different kinds of loads given below:

1. Electricity
2. Cooling
3. Refrigeration
4. Space Heating
5. Water Heating
6. Natural Gas
7. Hydrogen
8. Super-Hot Temperature

Energy Research Program – 3rd Call

Climate and Energy Funds of the Federal Government - handled by the Austrian Research Promotion Agency (FFG)

Each of the load has time resolution index of *time* and can be used by 3-Day type or 8760-optimization models. However, the primary energy provided carriers are electricity from utility grids, central heating and central cooling technologies which act as marginal technologies in contrast to other DER technologies. The primary fuels in OptEnGrid include:

1. Natural Gas
2. Oil
3. Diesel
4. Bio-Diesel
5. Biomass
6. Hydrogen

and other fuels can be used to provide for DER technologies which ultimately satisfy the load demand to achieve high level energy balance. The complexity is even higher if individual sector energy balances are modelled for each DER technology taking into account primary energy inputs and end-user demands.

The electricity sector higher level energy balance of OptEnGrid is summarized in Figure 8.

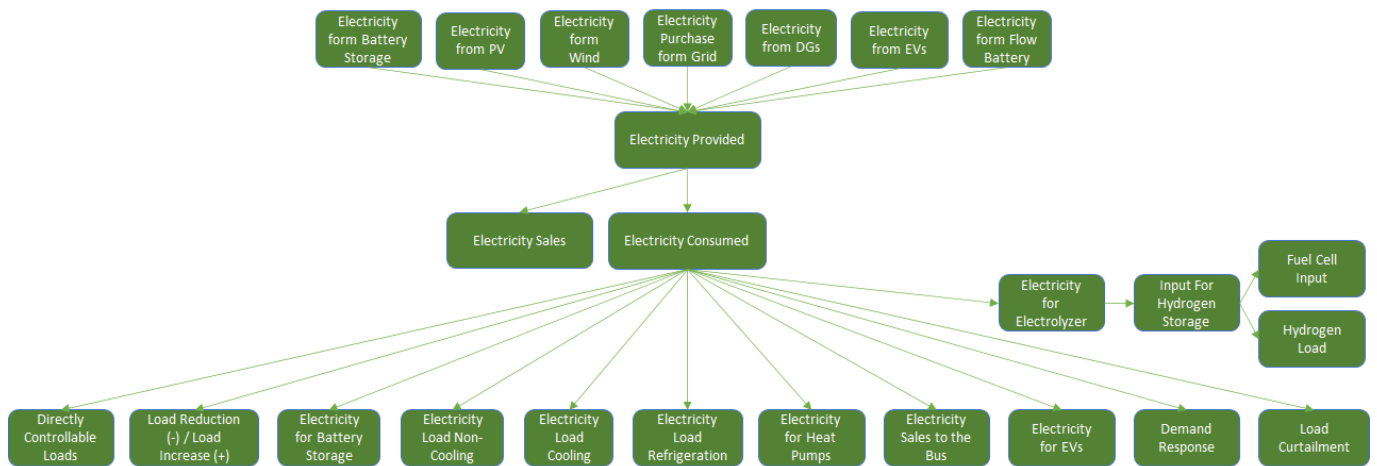

Figure 8: Electricity sector high level energy balance in OptEnGrid.

The heating sector higher level energy balance of OptEnGrid is summarized in Figure 9.

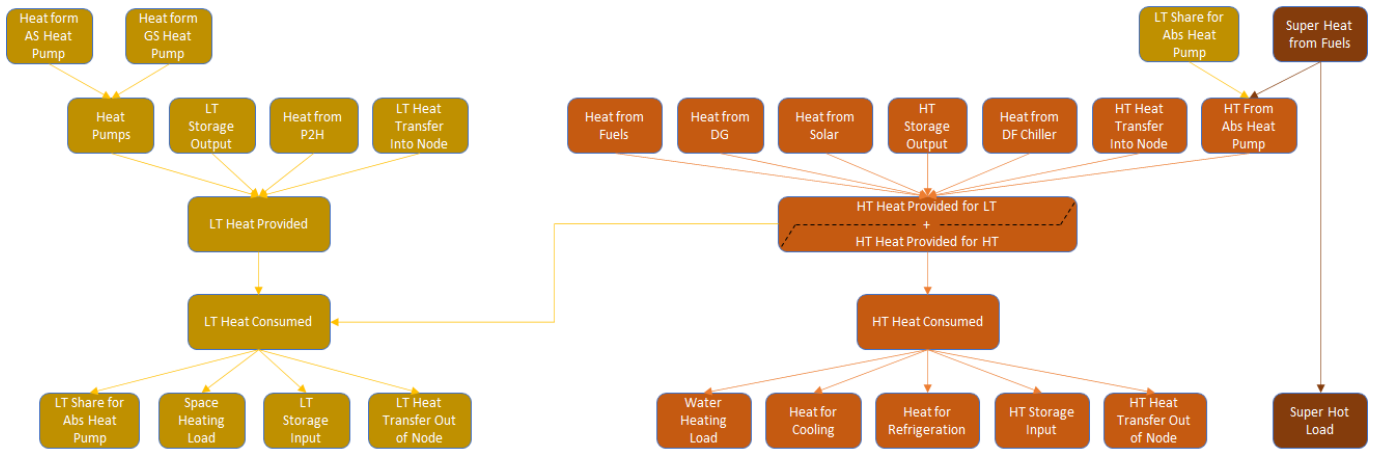

Figure 9: Heating sector high level energy balance in OptEnGrid.

The cooling sector higher level energy balance of OptEnGrid is summarized in Figure 10.

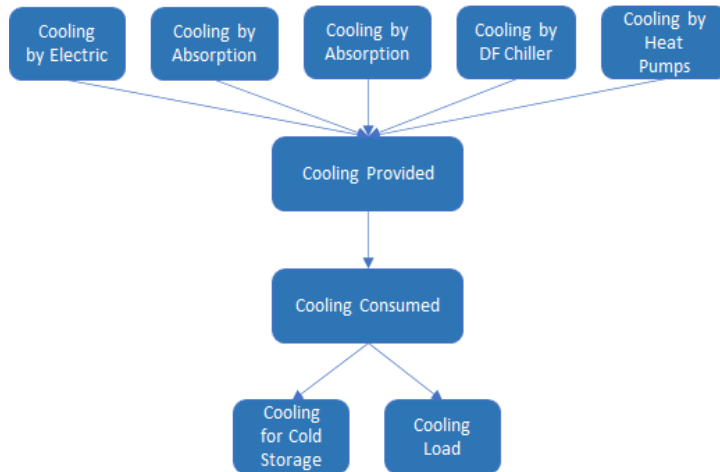

Figure 10: Cooling sector high level energy balance in OptEnGrid.

3.2 Use Cases

This sub-section contains major results of the use cases that were designed and optimally planned by using OptEnGrid tool. There is a variety of use cases that have been realized in the area of microgrid design and each use case adds validation of the modelling framework of the OptEnGrid project. Some selected use cases are summarized with respect to results and conclusions in the following sub-sections. The overview of some selected use cases with technology portfolio, sector use and objective function of optimization have been provided in Table 3.

Table 3: Overview of the selected use cases in OptEnGrid.

Use case	Sector of Use	Technology Portfolio	Optimization
Technologie und Forschungszentrum (TFZ) Microgrid Wieselburg	Electricity	Battery Storage and Solar PV	CO ₂ Min, Cost Min
Seasonal Solar Thermal and Heat Storage for a residential community in Lower Austria	Heating	Solar Thermal, Heat Storage and Central Heating	Cost Min, CO ₂ Min
Hydrogen: TFZ Extension	Electricity and Hydrogen	Solar PV, Wind Power, Hydrogen Electrolyzer, Hydrogen Storage, Hydrogen Fuel Cell Electrical Vehicles (FCEVs)	CO ₂ Min with Cost Constraint (Multi-Objective)
Hydrogen: Innsbrucker Kommunalbetriebe (IKB)	Electricity and Hydrogen	Hydrogen Electrolyzer, Hydrogen Storage and Hydrogen Fuel Cell Electric Vehicles (FCEVs)	Cost Min
Helsinki Energy System	Heat, Electricity and Hydrogen	CHPs, Central Heating Boilers, Solar Thermal, PV, Wind Turbines, Heat Pumps, Absorption Heat Pumps, Heat Storage, Batteries, Hydrogen Technologies	Cost Min, CO ₂ Min, Multi-Objective
Validation of the Solar Thermal Model	Heating	Solar Thermal	CO ₂ Min
World Direct Gebäude in Tirol	Electricity, Heat and Cooling	Heat pump, Heat storage, PV, P2H, Battery	Cost Min
Boiler Pool	Heat and Electricity	PV, P2H, Heat Storage	Cost Min

These are the most significant use cases which were analyzed with OptEnGrid project and are presented in the following sub-section with respect to motivation, objective, methodology, results and conclusion. Other use cases, for example *Stadtwärme Lienz*, *Smart Village Mödersdorf*, *Energy Quartier Plus Ottenstein*, etc. are not presented in order to keep an acceptable length for the final report.

3.2.1 TFZ Microgrid Use Case

The main objective of the Technologie und Forschungs Zentrum (TFZ) Microgrid Lab is to integrate new DER technologies such as solar PV, battery energy storage systems and electric vehicles at the TFZ Wieselburg site to create a real microgrid testbed facility. The Microgrid Lab includes two buildings: the new fire fighter department and the TFZ Wieselburg building complex. The new technologies are a photovoltaic system, an electric storage device and electric car charging stations. The main existing technologies are two wood chip boilers, thermal storage device and a absorption chiller. For the planning of the new DER technologies at the TFZ site, OptEnGrid was used to optimize the capacities and operation dispatch of the microgrid. With use of data related to load profiles, weather forecasts, techno-economic parameters of the DER technologies, utility prices from the energy market, marginal carbon emissions for the utility electricity purchase and site area constraints, the MILP optimization resulted in new DER technology portfolio of solar PV having 74kWp capacity and a battery energy storage system having 60 kWh capacity, which also got installed. With the help of existing biomass wood chip boilers and the optimal new DER technologies, the total annual energy costs are reduced by 12% and total annual carbon dioxide emissions are reduced by 18% as compared to the reference case where 100% electricity is purchased from the grid. Moreover, the EV charging stations are also realized for the storing of solar PV surplus and using it for charging the electric vehicles at TFZ site. The simplified TFZ Microgrid diagram together with the optimization results are shown in Figure 11.

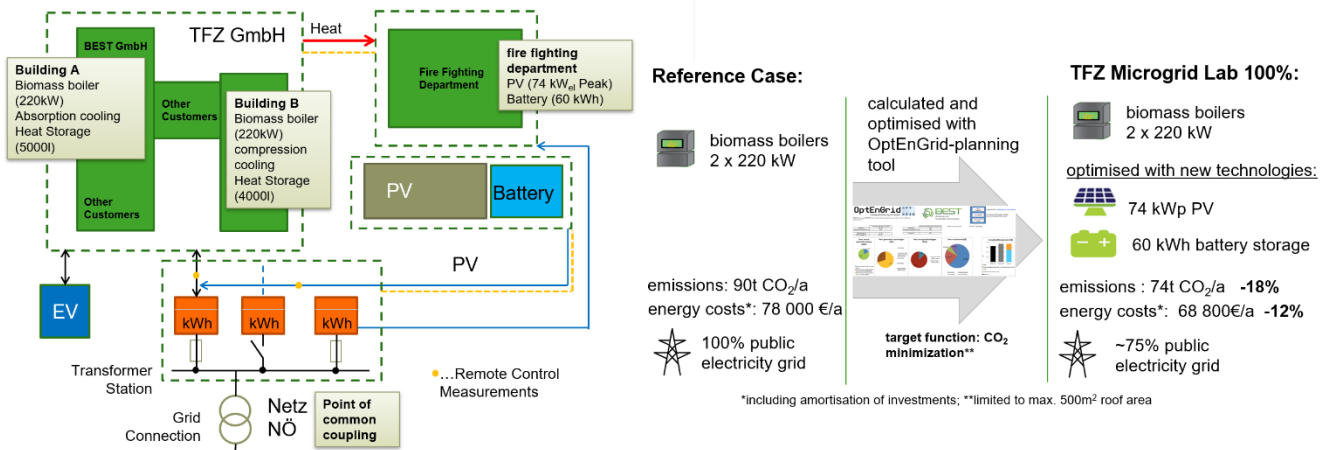

Figure 11: Topology of TFZ Microgrid Lab and optimization results as compared to reference case.

The optimal operation dispatch in a typical weekend-day in the month of September is provided in **Fehler! Verweisquelle konnte nicht gefunden werden.** which shows the use of solar PV self-consumption as well as charging the battery storage system and via solar PV surplus then discharging in the off-peak times.

As this use case is a real life example of the microgrid lab, the data gathered via different sensors and measuring devices is recorded in the database for real-time monitoring and analysis. The microgrid lab serves as a testbed for microgrid controller strategies where model predictive control based supervisory controller is used for the real-time optimization of the DER technologies. A test for optimization was performed for a typical weekend using MILP based controller techniques at TFZ and was compared with

Energy Research Program – 3rd Call

Climate and Energy Funds of the Federal Government - handled by the Austrian Research Promotion Agency (FFG)

the reference case of the microgrid operation without real-time optimization of the DER technologies. The comparison is provided in Figure 13. The first graph shows the conventional operation of the DER technologies without any forward-looking capability in predicting the solar PV output and load and no real-time optimization. It can be seen that in conventional operation, the battery utilization is limited. The second graph shows the real-time optimization of the DER technology in the microgrid where model predictive control provides forward-looking capability and optimization provides the maximum utility of battery energy storage system which charges in low-tariff times and discharges in high-tariff times, thus, reducing the electricity purchased from the utility. This test provided 23.30% of savings in total energy costs for the operation duration.

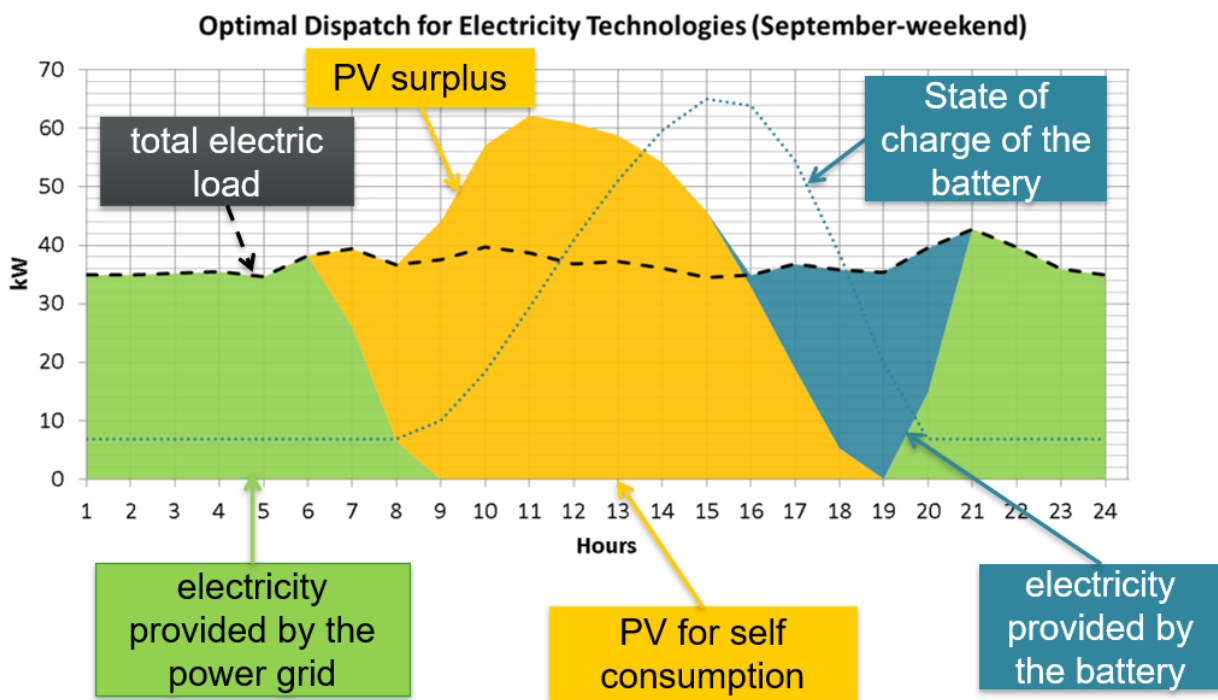

Figure 12: Optimized operational dispatch of the solar PV with battery energy storage system at TFZ Microgrid Lab

Energy Research Program – 3rd Call

Climate and Energy Funds of the Federal Government - handled by the Austrian Research Promotion Agency (FFG)

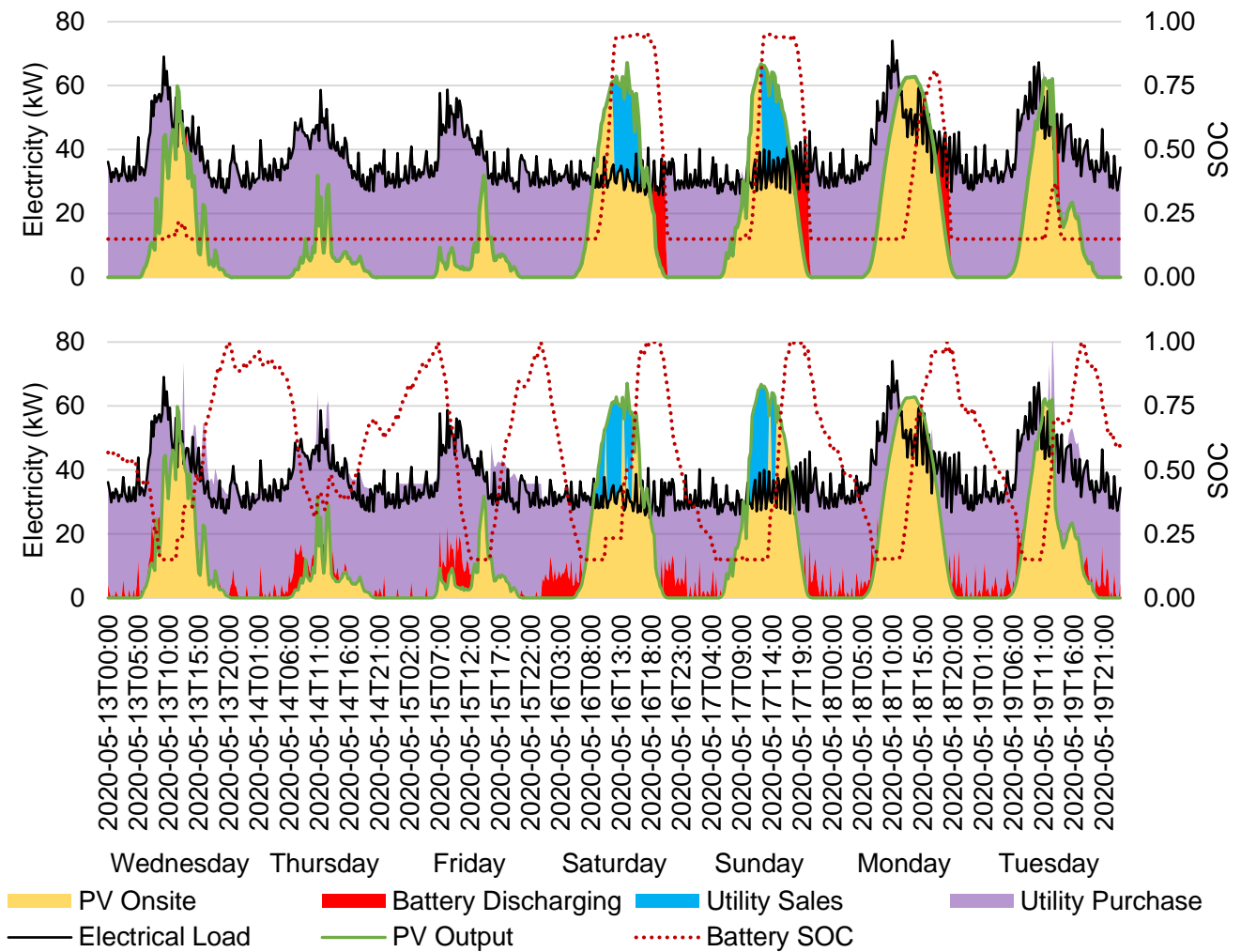

Figure 13: Operational dispatch for the microgrid lab use case in conventional operation mode (top graph) and optimization operation mode (bottom graph).

3.2.2 Seasonal Solar Thermal and Heat Storage for a residential community in Lower Austria

The optimal design of microgrids with thermal energy system requires optimization techniques that can provide investment and scheduling of the technology portfolio involved. In the modeling of such systems with seasonal storage capability, the two main challenges include the low temporal resolution of available data and the non-linear cost versus capacity relationship of solar thermal and heat storage technologies.

In this use case, these aforementioned challenges are overcome by developing two different optimization models based on mixed-integer linear programming i.e. 3-Daytype (Opt-3D) model and 8760-hour (Opt-8760) model of OptEnGrid tool with objectives to minimize the total energy costs and carbon dioxide emissions. The piecewise affine functions are used to approximate the non-linear cost versus capacity behavior of solar thermal and heat storage technologies as given in sub-section 3.1.5. Both Non-PWA and PWA cost parameters are used in this case for creating different scenarios of optimization.

The developed methods are applied to the optimal planning of a case study that considers a set of community residential buildings in Lower Austria. Only space heating load is considered for this study and it is generated using TRNSYS [10] simulations on hourly basis for a whole year. Central heating through

Energy Research Program – 3rd Call

Climate and Energy Funds of the Federal Government - handled by the Austrian Research Promotion Agency (FFG)

biomass fuel, solar thermal and heat storage technologies are considered to satisfy the thermal load. The heat storage considered for this study is a hot water tank storage. The schematic of the use case is given in Figure 14.

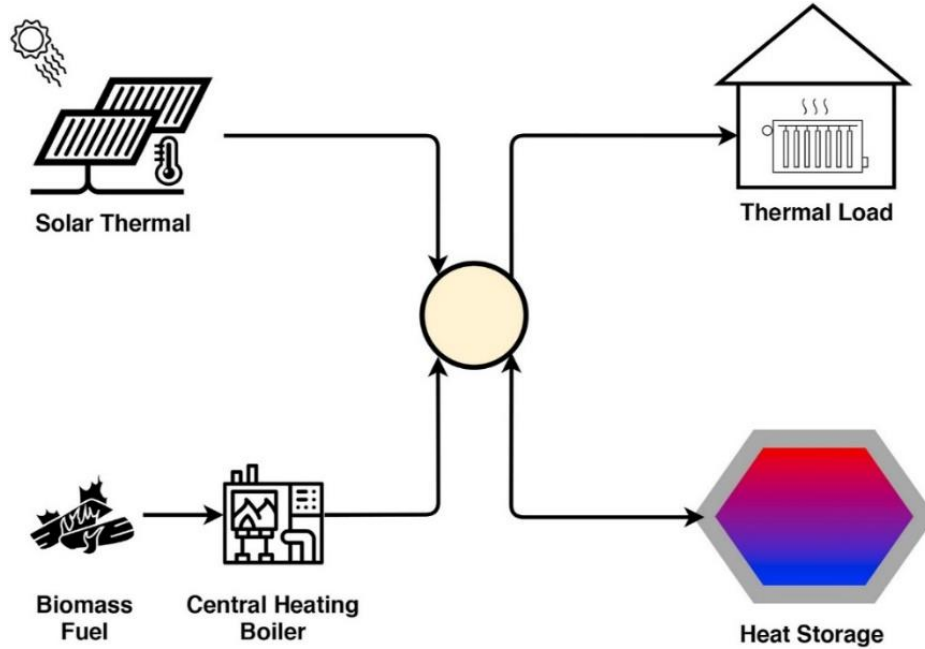

Figure 14: Schematic diagram of the investigated seasonal solar thermal and heat storage use case.

The full yearly demand profile of the thermal load, its corresponding Opt-3D demand profiles for week days, peak days and weekend days, the full yearly weather profiles of the location and its corresponding Opt-3D weather profiles are shown in the Figure 15. Different scenarios for the optimization and testing framework are given in Table 4.

Table 4: Different scenarios for the optimization and testing framework.

Scenario	Optimization Model	Minimization
Scenario-0 (a): Basecase	Opt-3D	Cost
Scenario-0 (b): Basecase	Opt-8760	Cost
Scenario-1 (a): 0% relaxation w.r.t basecase	Opt-3D	Cost
Scenario-1 (b): 0% relaxation w.r.t basecase	Opt-3D	CO ₂
Scenario-2 (a): 0% relaxation w.r.t basecase	Opt-8760	Cost
Scenario-2 (b): 0% relaxation w.r.t basecase	Opt-8760	CO ₂
Scenario-3: 50% relaxation w.r.t basecase	Opt-3D	CO ₂
Scenario-4: 50% relaxation w.r.t basecase	Opt-8760	CO ₂

Energy Research Program – 3rd Call

Climate and Energy Funds of the Federal Government - handled by the Austrian Research Promotion Agency (FFG)

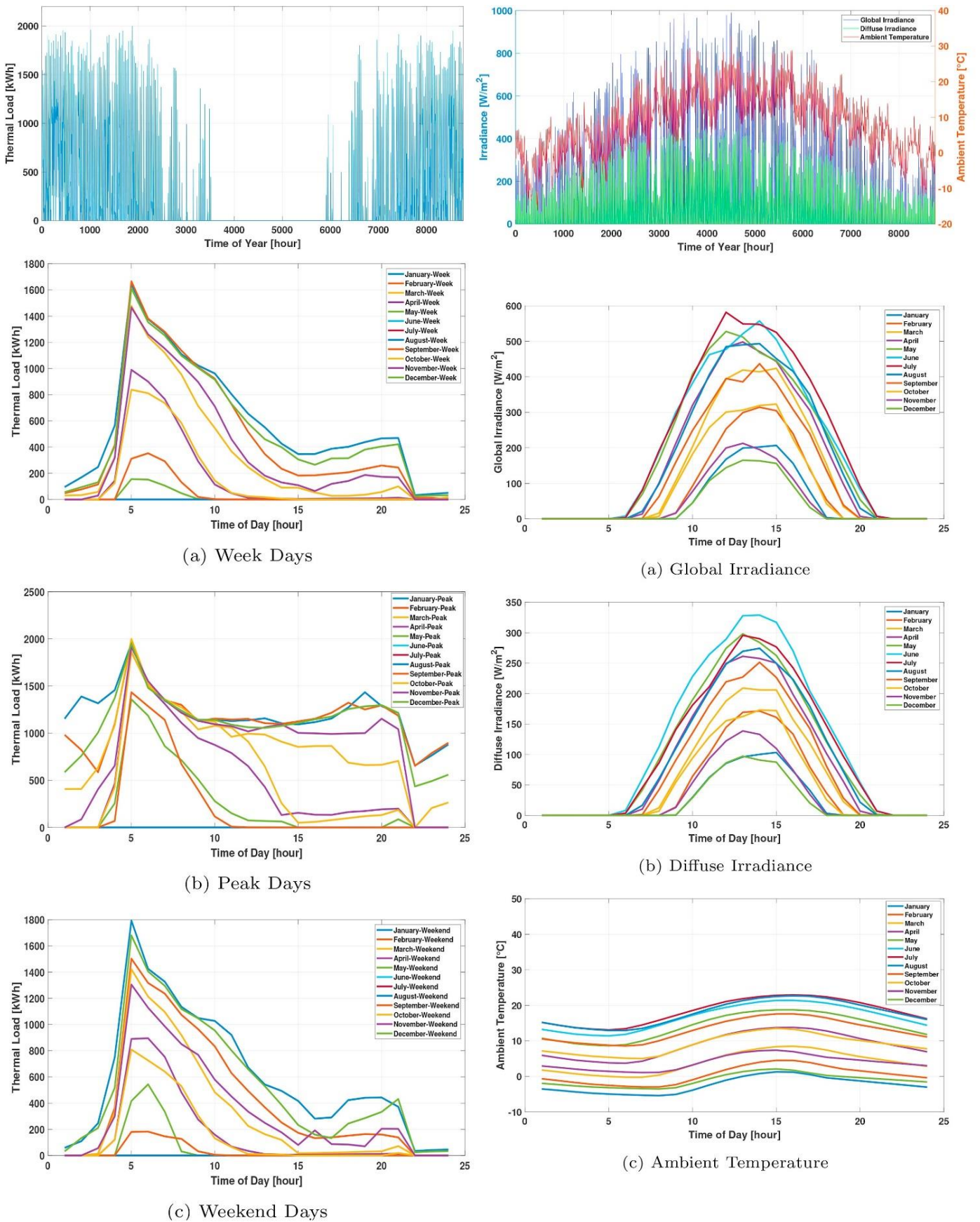

Figure 15: Time-series input data for the optimization model of the seasonal solar thermal and heat storage use case

Scenario-0 is the basecase where the central heating technology is only considered for supplying to the load and no heat storage and solar thermal technologies are allowed. The optimal total energy costs and total CO₂ emissions are calculated for both models by using cost minimization. These costs and CO₂ emissions are then taken as reference for the rest of scenarios and objective function savings. Costs and CO₂ emissions are calculated relative to these references in the respective cost and CO₂ optimization runs for Scenario-1 to Scenario-4.

Scenario-1 includes the cost and CO₂ minimization using the Opt-3D model with 0% relaxation to their respective reference costs and CO₂ emissions. A 0% relaxation means that the objective function from the optimization case cannot be higher than the one from the reference case. Scenario-2 includes the cost and CO₂ minimization using the Opt-8760 model with 0% relaxation to their respective reference costs and CO₂ emissions. Scenario-3 and Scenario-4 include the CO₂ minimization using the Opt-3D and the Opt-8760 models respectively with 50% relaxation in the reference costs, meaning that the objective functions can be 50% higher than the one in the reference cases, allowing for more progressive results. Scenario-1 to Scenario-4 are tested by considering fixed linear (Non-PWA) cost functions as well as PWA cost functions for both models.

The results are compared based on the investment decisions by the optimizer, objective function savings, absolute run time, objective function difference and the run time savings between both the Opt-3D and the Opt-8760 models for all scenarios. Table 5 shows the detailed results of this use case.

In summary, the Opt-3D and the Opt-8760 models provide comparable results in cost minimization by both using Non-PWA and PWA cost functions for Scenario-1 and Scenario-2 respectively. The investment decision results for CO₂ minimization using Non-PWA cost functions for the Opt-3D model in scenario-1 and scenario-3 are well aligned with the investment decision results for CO₂ minimization using Non-PWA cost functions for the Opt-8760 model in scenario-2 and scenario-4 respectively. However, these investment decisions vary significantly when considering the CO₂ minimization using PWA cost functions in scenario-1 to scenario-4 with Opt-8760 model performing better than the Opt-3D model by providing bigger investments in solar thermal and heat storage technologies, thus contributing to a maximum of 76.6% CO₂ savings. In all the scenarios, the Opt-3D model has significant run time savings as compared to the Opt-8760 model because of its lower time resolution.

The results of scenario-4 with PWA cost functions indicate a huge reduction in central heating capacity followed by the big investments in solar thermal and heat storage capacities. This is because of the use of the PWA functions, which considers lower costs for higher capacities of these technologies. The objective function savings are about 76.6% with a 1.5 GWh capacity of heat storage (25,918 m³) and a 4512 kW capacity of solar thermal (5679 m² of solar collector field area). The resulting optimal dispatch of scenario-4 using the PWA cost functions is demonstrated in Figure 16.

The dispatch results of scenario-4 using the PWA cost functions show the seasonal effect of the heat storage by storing the energy in summer months and using the stored heat in winter months. The detailed modelling and results for this use case are given in the published work [6].

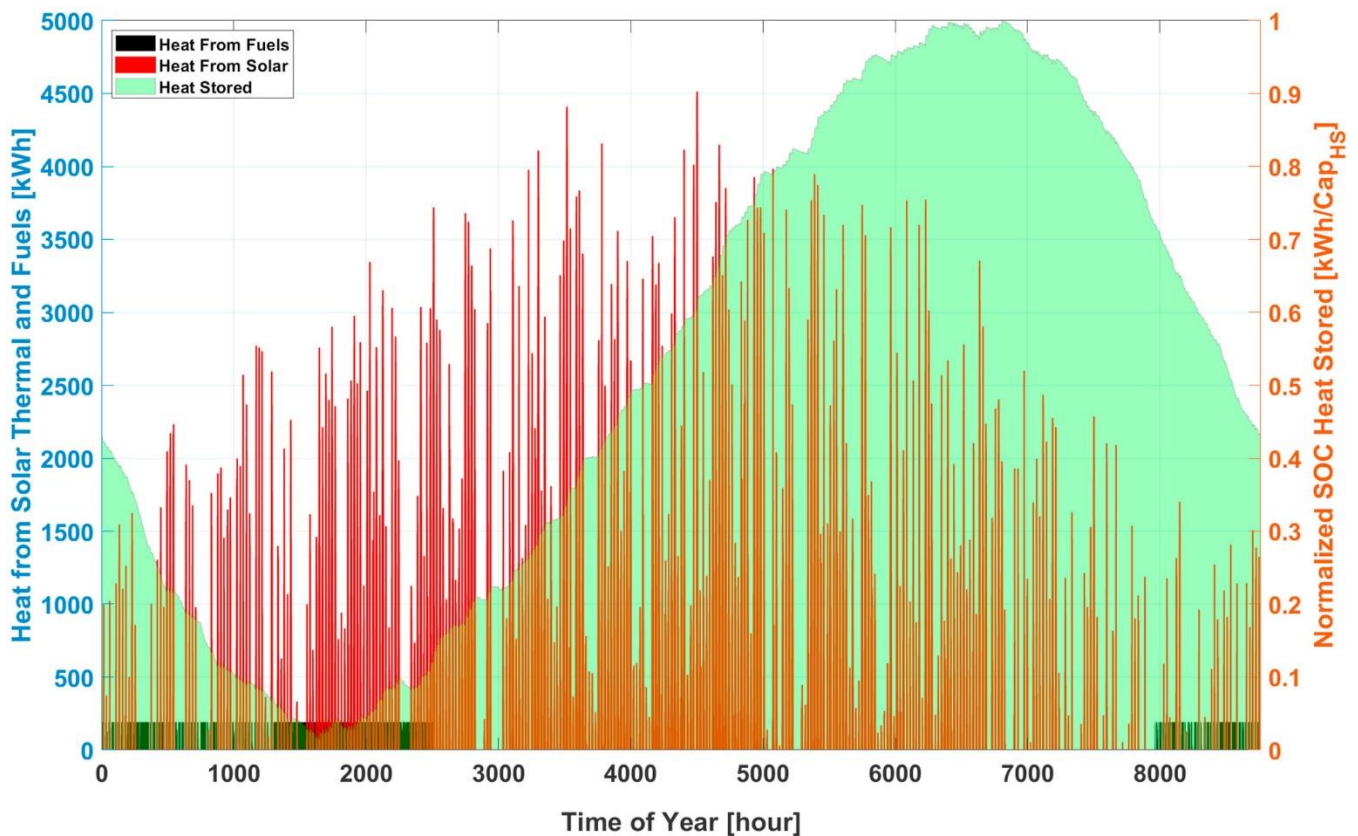

Figure 16: Optimal dispatch for Scenario-4: 50% relaxation w.r.t basecase considering the Opt-8760 model with CO₂ minimization using piecewise affine (PWA) cost functions.

3.2.3 Hydrogen-TFZ Extension

In this use case, optimal planning of microgrids including the hydrogen energy system has been investigated through the mixed-integer linear programming model of OptEnGrid. A real case study is analyzed by extending the microgrid lab facility (TFZ) in Wieselburg, Austria. The case study considers the hydrogen production via electrolysis, seasonal storage and fueling station for meeting the hydrogen fuel demand of fuel cell vehicles, busses and trucks. However, the upgrades to TFZ have not started at this moment.

The main motivation behind this use case is decarbonizing the mobility by finding economical and sustainable strategies using hydrogen from renewable energy sources. The decarbonization of the mobility sector is both urgent and an important challenge in fulfilling the European Union's commitment towards the carbon neutrality by 2050 and for the global effort to the implementation of the Paris Agreement [11]. Thus, hydrogen is considered to be one of the solutions to achieve this challenge of decarbonization in the mobility sector.

The microgrid testbed at Wieselburg is the first microgrid research lab in Austria that integrates renewable energy, utility electricity, heat technologies, biomass technologies, electro-mobility, storage technologies, building control as well as smart network communication that allows for multiple MILP based model predictive control strategies. The existing infrastructure at the microgrid testbed mainly consists of solar PV, battery storage, electric vehicle charging station, emergency diesel generator, point of common coupling for utility electricity import/export, biomass boilers, heat storage, absorption cooling and

Energy Research Program – 3rd Call

Climate and Energy Funds of the Federal Government - handled by the Austrian Research Promotion Agency (FFG)

compression cooling technologies distributed in the three main buildings of the site. These technologies are responsible for achieving a balance of sources and loads in the multi-energy system concept (electricity, heating and cooling) of a microgrid. The new infrastructure required for the production, storage and use of the hydrogen fuel contains more solar PV, wind power, water electrolyzer, hydrogen seasonal storage tank and hydrogen fuel dispensers with fuel pumps. The existing and optimized additional infrastructure of the microgrid testbed is shown in Figure 17.

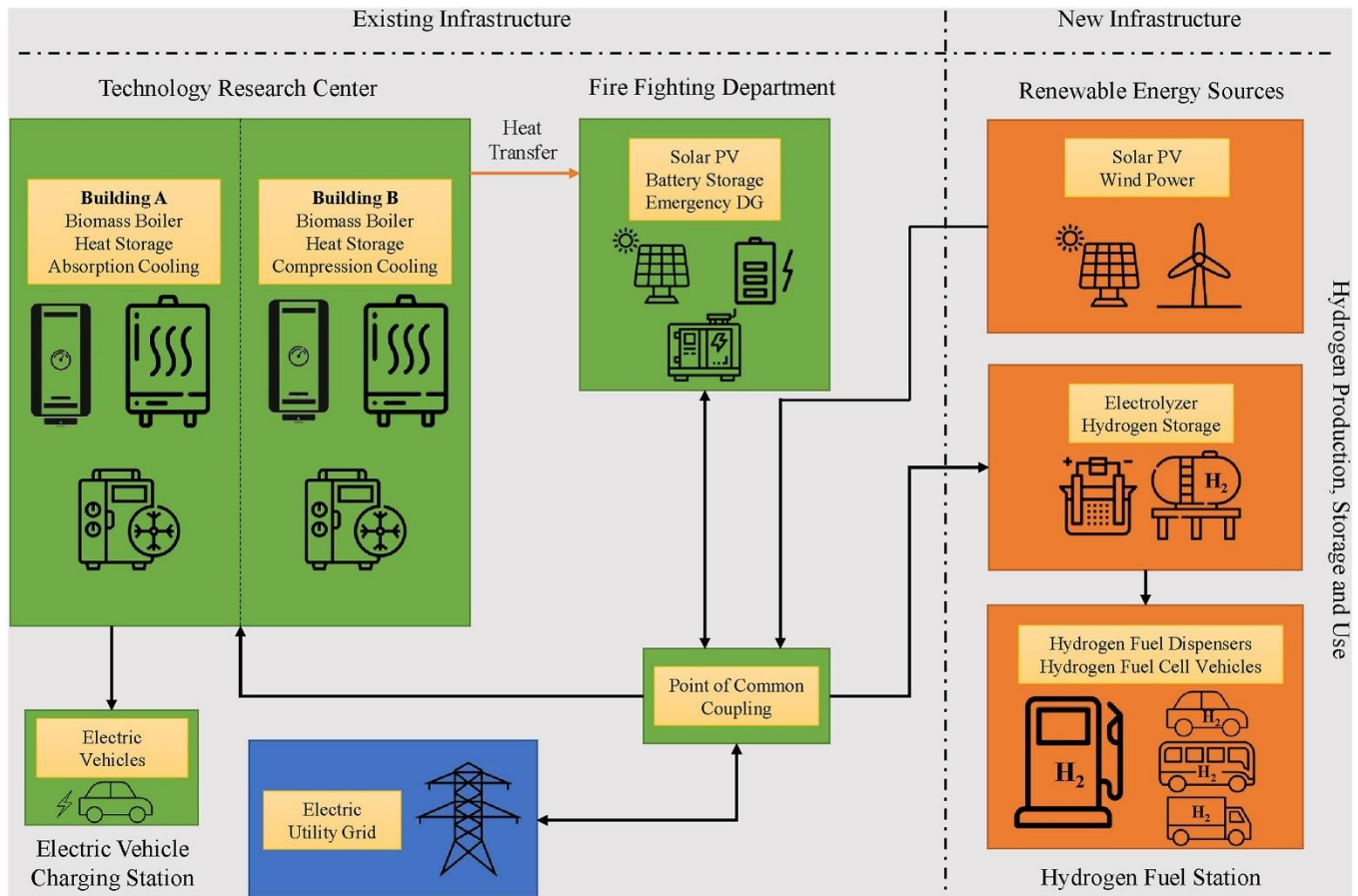

Figure 17: Hydrogen use case at TFZ microgrid testbed, Wieselburg, Austria.

The hydrogen fleet consists of Fuel Cell Electric Vehicles (FCEVs), Fuel Cell Electric Buses (FCEBs) and Fuel Cell Electric Trucks (FCETs). The FCEBs are based on the real schedule of the conventional fuel busses in the region [12]. The FCEVs and the FCETs are based on the average annual mileage of the conventional fuel passenger cars and trucks in the region [13]. The FCETs are further divided into three sub groups based on the distance covered as small, medium and large FCETs. The hourly hydrogen demand of the entire hydrogen fleet on working and weekend days is shown in Figure 18. This hydrogen fuel consumption in kgH₂ is then converted into hydrogen energy demand in kWh (1 kgH₂ is equivalent to 33.33 kWh of energy content [14]) and is treated as the final hydrogen energy demand for the optimization problem. Together with the hydrogen fuel, it is also important to consider the electric consumption of the hydrogen fuel pumps required for dispensing the fuel. This electric consumption is considered as 1.1 kWh per kgH₂ dispensed [15]. The yearly profiles of the hydrogen energy demand in kWh and the electric energy consumption of hydrogen dispensing pumps in kWh are constructed by extrapolating the respective

hourly demand profiles of the week and weekend days. The maximum energy demand in an hour for the hydrogen fuel and hydrogen dispensing pumps is around 2034 kWh and 67 kWh respectively in the whole year.

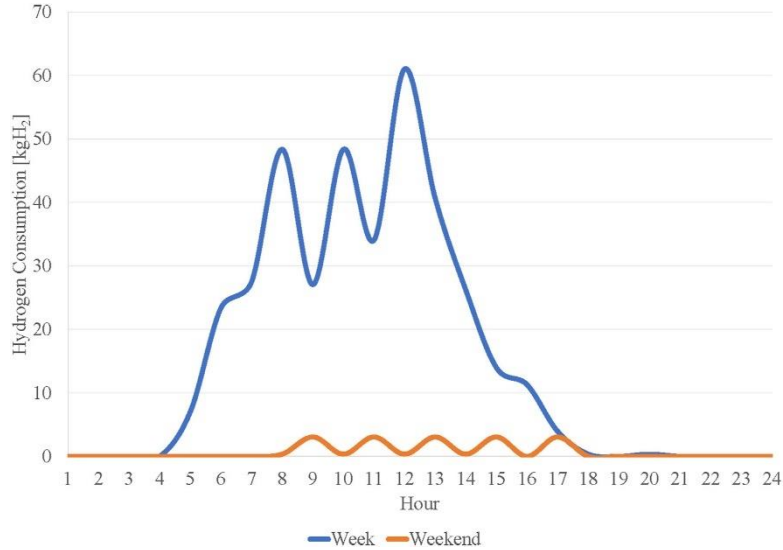

Figure 18: The hourly hydrogen demand of the entire fleet in TFZ-hydrogen use case.

The economic parameters of the microgrid technologies in this use case are given in Table 5.

Table 5: The economic parameters of the microgrid technologies in TFZ-hydrogen use case.

Technology	Variable Capital Costs	O&M Costs	Lifetime
	[€/kW or €/kWh]	[€/kW or €/kWh per year]	[years]
Solar PV	842	9	25
Wind Power	1247	48	15
Alkaline Electrolyzer	920	19	25
Hydrogen Storage	14	0	30

The case study considers two reference cases i.e. the diesel basecase and the utility basecase. The diesel basecase satisfies the mobility demand by the diesel fuel. After setting up the reference cases, the investment optimization is performed relative to each reference case through sensitivity analyses. In each optimization scenario of the investment case, the total annual CO₂ emissions are minimized by keeping the limit on the total annual energy costs given by the cost constraint parameter. The results include the optimal sizing and the full-year operational dispatch of the technologies. The results also include the comparisons with the reference cases in terms of the CO₂ savings, the total annual energy costs, the total annual carbon dioxide emissions, H₂-Diesel cost gap and carbon prices to close that H₂-Diesel cost gap.

The main results of the optimization scenarios with respect to diesel basecase are shown in Figure 19. With respect to the diesel basecase, the investment optimization results of the energy system are infeasible unless the investment costs are increased by at least 30% relative to the diesel basecase costs. From 30% to 100% increase in the diesel basecase costs, the investment optimization provides a minimum CO₂ savings of 66.32% and a maximum CO₂ savings of 99.21%.

Energy Research Program – 3rd Call

Climate and Energy Funds of the Federal Government - handled by the Austrian Research Promotion Agency (FFG)

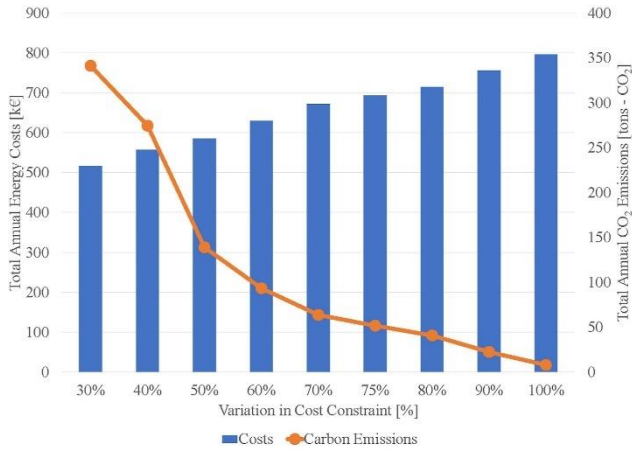

(a) Costs and CO₂ emissions

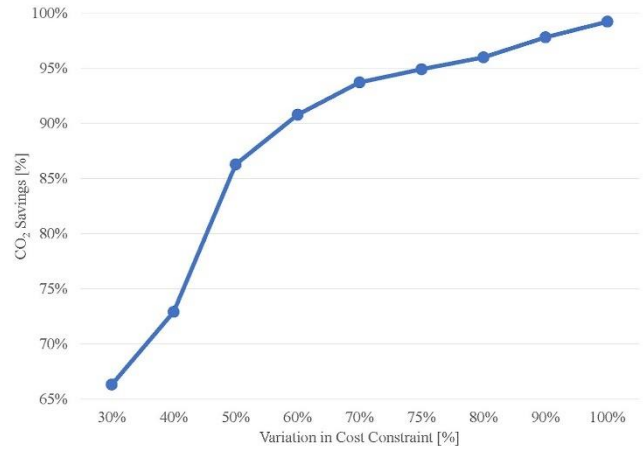

(b) CO₂ savings

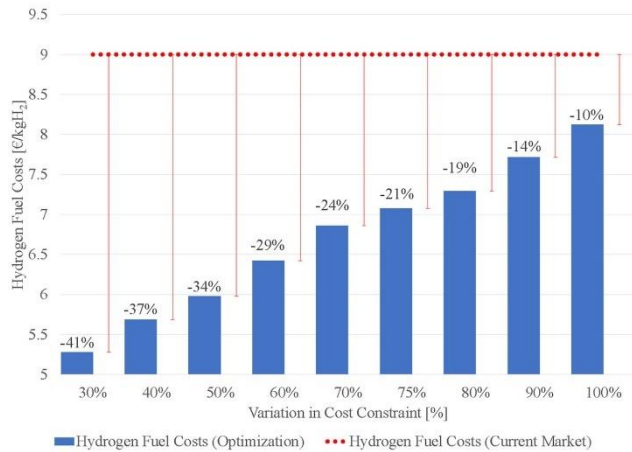

(c) Hydrogen fuel costs

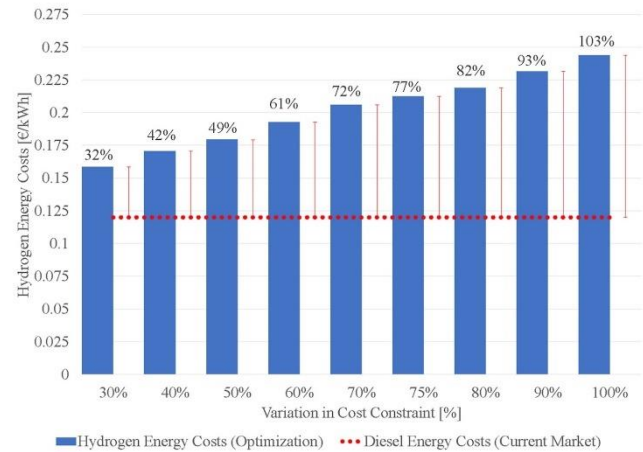

(d) Hydrogen energy costs

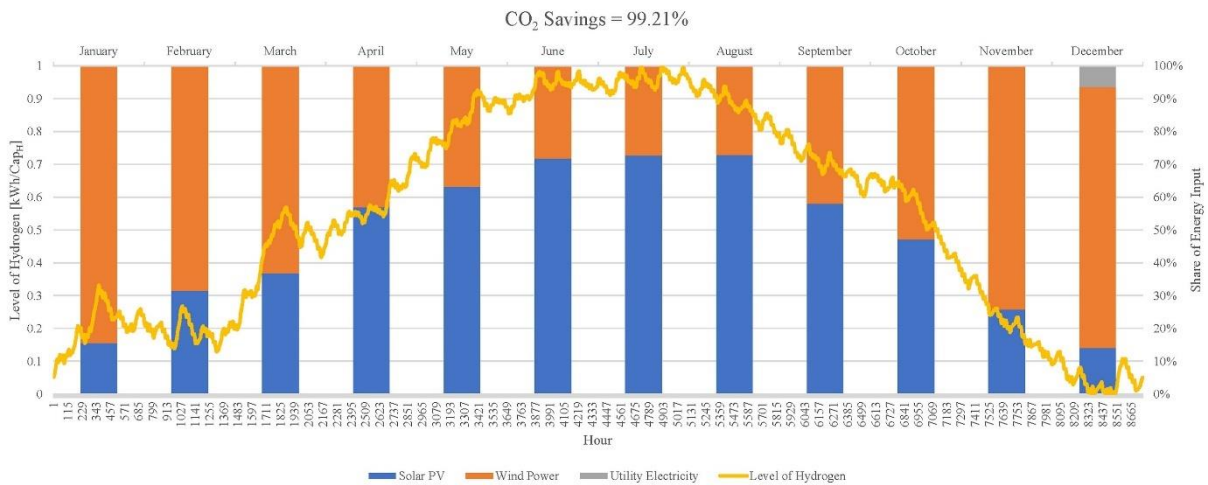

(e) Dispatch for 100% Variation in Cost Constraint

Figure 19: Main results of optimization scenarios with respect to diesel basecase in in TFZ-hydrogen use case.

These results show that the renewable energy sources, if penetrated highly into the microgrids, can significantly reduce the carbon footprint and make use of the renewable hydrogen fuel to enable the

decarbonized energy transition in the mobility sector. Evidently, the seasonal hydrogen storage has an important role in this decarbonized energy transition as it captures the seasonal variability of the renewable energy sources. From an economic point of view relative to both reference cases, the optimal hydrogen fuel costs (€/kgH₂) are lower than the current market costs of the hydrogen fuel. Therefore, the hydrogen fuel is considered to be cheaper if it is produced by renewable energy based microgrids close to the point of delivery of the fuel. However, the optimal hydrogen energy costs (€/kWh) are higher than the current diesel fuel costs in all investment optimization scenarios. This draws an attention to make the hydrogen energy price competitive with the diesel fuel price. The carbon price increases the diesel fuel costs and reduces the current difference of the costs between the hydrogen fuel and the diesel fuel if applied in the policy framework. For achieving a CO₂ saving of around 66%, a carbon price of around 124 €/tonne-CO₂ is estimated on the diesel fuel to make the hydrogen and the diesel fuel costs competitive with each other. For achieving almost 100% CO₂ savings, a carbon price of more than 400 €/tonne-CO₂ is estimated on the diesel fuel to close the H₂-Diesel cost gap. The detailed modelling and results for this use case are given in the published work [7].

3.2.4 Hydrogen- Innsbrucker Kommunalbetriebe IKB

A optimization based cost analysis for a hydrogen plant for the Innsbrucker Kommunalbetriebe (IKB) was carried out by using the created hydrogen system model of OptEnGrid. The main requirements for this use case consider the daily production volume of 200 kg hydrogen fuel that has to be loaded to the hydrogen busses at production and filling site. The hydrogen is produced by using electricity in the electrolyzer. The objective of the optimization is to minimize the overall energy system costs and optimally plan the hydrogen energy system for this use case. The 3-Daytype optimization model is being used for this case study as it is relatively small and requires quick optimal planning insights for this use case. Furthermore, we do not expect a strong seasonal dependency and thus the 3-Daytype model is sufficient.

The demand profile of the hydrogen fuel is created by converting the 200 kgH₂ of daily production to energy content in kWh i.e. 6666 kWh (1 kgH₂ = 33.33 kWh/kgH₂). The hydrogen busses are assumed to be refueled at three different times in a day i.e. 07:00, 12:00 and 17:00 hrs. Both Alkaline Electrolyzer (AEL) and Proton Exchange Membrane Electrolyzer (PEMEL) technologies are considered for this use case. The economic parameters of the technologies considered in this use case are given in Table 6.

Table 6: Economic parameters of the IKB-hydrogen use case.

Technology	Variable Capital Costs	O&M Costs	Lifetime
	[€/kW or €/kWh]	[€/kW or €/kWh per year]	[years]
Alkaline Electrolyzer	920	19	25
PEM Electrolyzer	1470	13	25
Hydrogen Storage	14	0	30

The efficiencies of both electrolyzer technologies are considered to be 70%, the efficiency of the hydrogen pressurizer is considered to be 90% and 1% per day losses are considered for the hydrogen storage in this use case. The electricity is considered to be purchased by two different kinds of tariffs. One tariff is based on the Time-of-Use (ToU) and the other tariff is based on the Energy Exchange Austria (EXAA)

prices of electricity. The peak tariff rate is 7.55 €/kWh (Time: 06:00-22:00 hrs) and off-peak tariff rate is 7.11 c/kWh (Time: 22:00-06:00 hrs). The other tariff considers the historical electricity market price data (EXAA) on 15 min basis for the year 2018. This tariff is shown in Figure 20 for the typical days of the months.

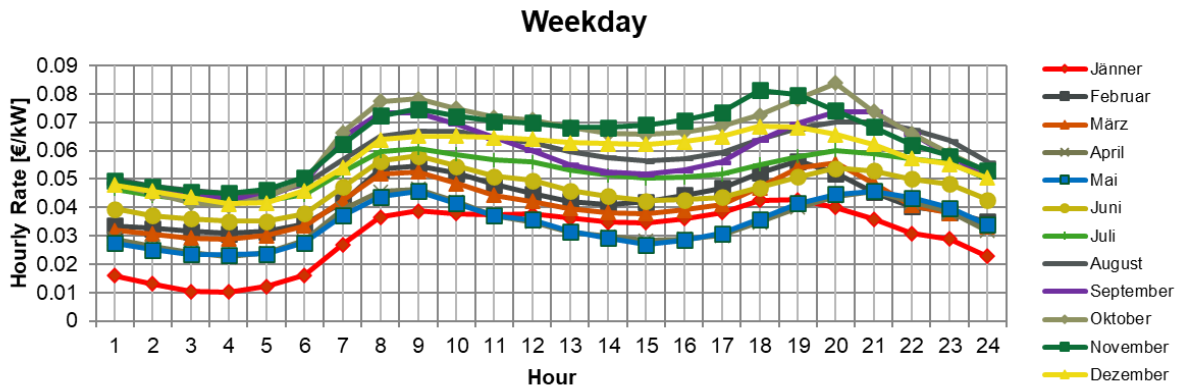

Figure 20: EXAA electricity tariff for IKB-hydrogen use case.

Each use case has its own reference case or basecase. The basecase optimization for this use case considers the cost minimization using ToU tariffs. After setting the basecase, the cost optimizations are performed relative to the basecase by considering the EXAA tariff. The results of the optimization are given in Table 7.

Table 7: The cost minimization results of the IKB-hydrogen use case.

	Reference Case (AEL)	Reference Case (PEMEL)	Cost Minimization (AEL)	Cost Minimization (PEMEL)
Description	Electricity Purchase: High and Low Tariff	Electricity Purchase: High and Low Tariff	Electricity Purchase: Market Price (EXAA)	Electricity Purchase: Market Price (EXAA)
Total Annual Energy Costs incl. amortized investments [k€/Jahr]	296	303,5	187,9 (-36,5%)	198,3 (-34,7%)
Total Annual CO₂ Emissions [t/Jahr]	367,9	367,9	367,6	367,7
H-Electrolyzer [kW]	293	293	439	370
H-Storage [kWh]	3611	3611	3750	3510

The optimal dispatches for the reference case (AEL) and its corresponding optimization are shown in the Figure 21 for typical weeks in January and December months. The dispatch of the reference case show the continuous hydrogen production throughout the day while the results of the relative cost optimization case shows the discontinuous production of the hydrogen which ultimately saves total energy costs of the system.

Optimal Dispatch: Reference Case (AEL)

Optimal Use of the Technologies (January-Weekday)

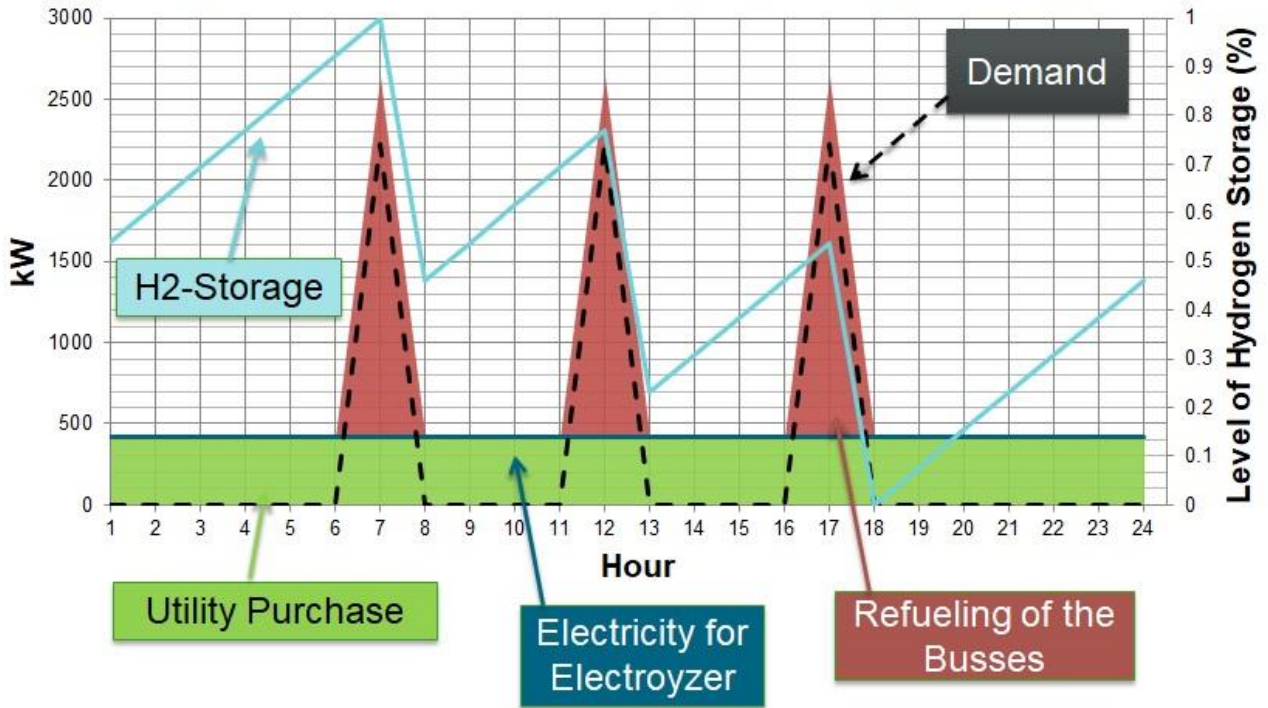

Optimal Dispatch: Cost Minimization (AEL)

January-Weekday

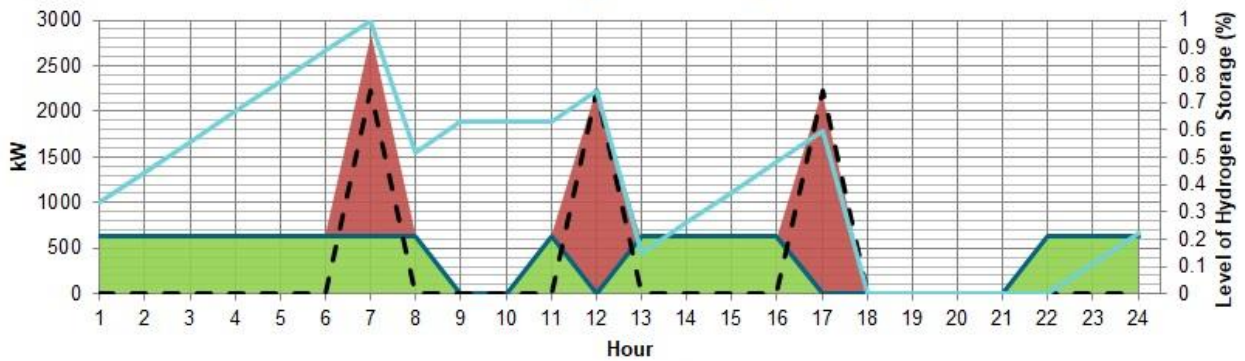

December-Weekend Day

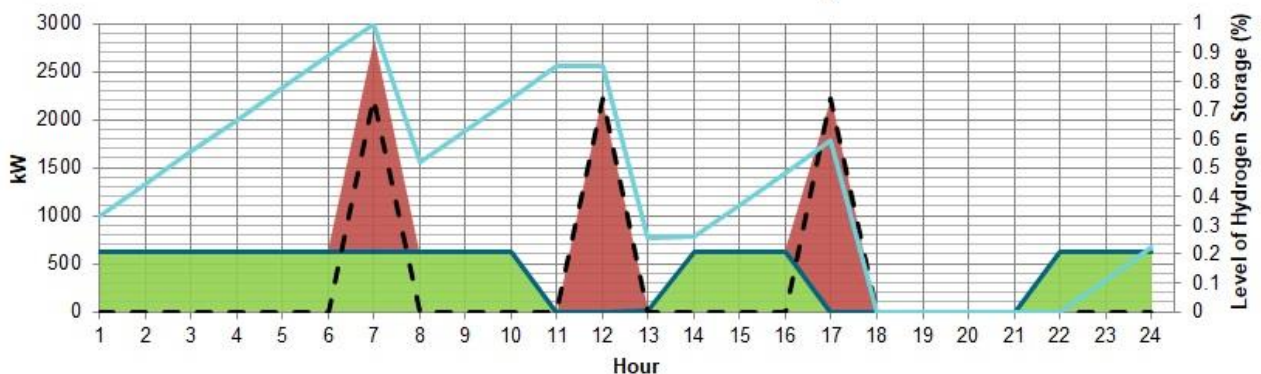

Figure 21: Optimal dispatch results of the IKB-hydrogen use case.

3.2.5 Helsinki Energy System

With around 7.6 TWh of heat consumption, Helsinki's district heating system (DHS) is one of the largest in Europe. Current heat production is primarily from coal and natural gas fired power plants that generate electricity, heating and (partly) cooling. In addition, the Helen Ltd. utility company (ESC) owns a 90 MW biomass heating plant and a 100 MW heat pump that also feeds the district cooling system. Two coal-fired power plants, which generate about 4.2 TWh of heat, are scheduled to be taken off the grid in 2024 and 2029. To compensate for the missing heat and to decarbonize the DHS, the *Helsinki Energy Challenge* was created, in which international teams of plant engineers, research institutes, universities, etc., developed energy concepts for the optimal energy supply.

The primary goal was to reduce CO₂ emissions and energy costs while using as little biomass as possible. The focus of the was purely on heat supply, the missing electricity (and cooling) from the power plants that are scheduled to go off-line was planned to be replaced by other technologies, which could be neglected in this conceptual energy design.

For the elaboration of the concepts, Helen Ltd. provided a comprehensive report and different data. These included an annual heat profile (see below), topologies, technical data on power plants, developments in energy costs and national CO₂ taxes, an exemplary deployment plan of future technologies, population growth of the city, general grid information, etc. These are shown in Figure 22.

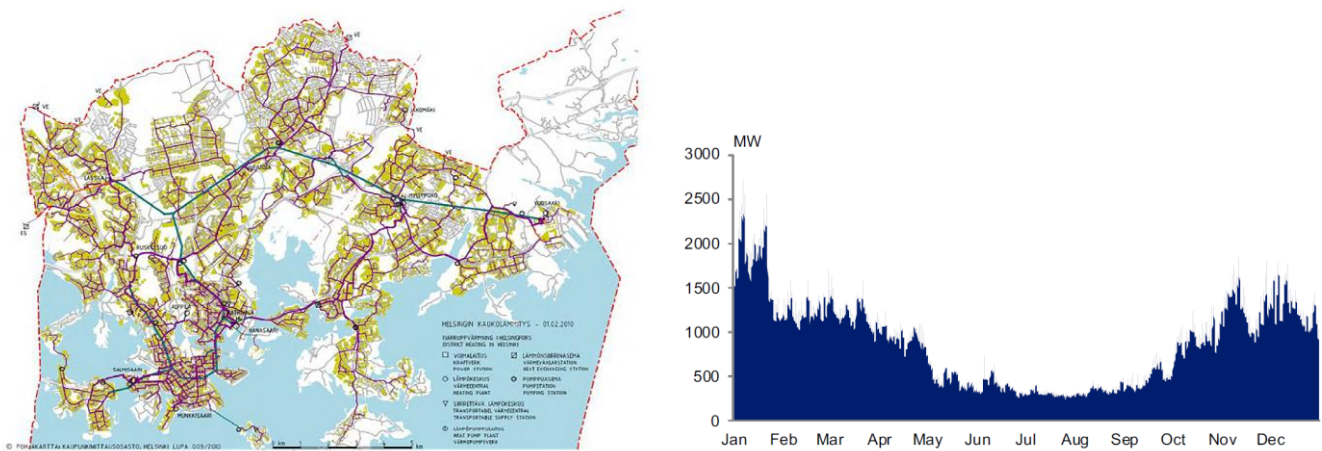

Figure 22: Complex topology of the heat network (left) and obtained load data profile (right).

The data from the report and other data generated from literature research, a mathematical model was created in OptEnGrid. The project offered an ideal opportunity to the newly developed 8760 optimization model, since volatile and renewable energy technologies were to be expected in advance. Above all, solar thermal and technological synergies with PV or wind turbines with heat pumps should be increasingly used in a seasonal storage system. Strongly fluctuating electricity markets (e.g. spot market) could also contribute significant added value in this modeling. earlier this year Helen Ltd. published the annual energy costs and the modeled status quo by OptEnGrid had a deviation of less than 10% to the real data.

For the optimization, all existing technologies in the capacity spectrum of the district heating system were taken into account in order to exclude a biased selection. The considered technologies included, in addition to the existing power plants and equipment, an expansion of the biomass heating plant and heat pump

systems (air-water, seawater-water) and an integration of solar thermal, PV, thermal and electric storage systems (Li-ion or redox flow), off-shore wind turbines and hydrogen technologies (electrolyzer, compressor, storage and fuel cells).

Already in the first optimization results, the technology combination of solar thermal collector and sensitive heat storage demonstrated a high potential for cost and CO₂ savings in the possible solution space. Based on this work two errors in the framework conditions of the optimization were diagnosed. On the one hand, thermal peaks in the DHS are also achieved by raising the surplus temperature. In that case the usage of the thermal storage would be reduced in reality. On the other hand, solar thermal collectors cannot be assumed to reach temperatures of 90 to 100 °C in winter and transition periods. For this purpose, the existing optimization model of OptEnGrid has two temperature levels (hot and low temperature – HT and LT) to solve the problem. For this reason, the following implementations were made in the optimization model:

- Differentiation of methodological approaches with respect to solar thermal: Since both, generation profiles and OptEnGrid-internal calculation for solar thermal output, were used, a binary factor was created, which can choose one of the two models.
- Time-varying temperature modeling of solar thermal collectors: In order to adapt the temperature-related solar thermal output to the transitional periods and the winter months, a model was implemented to assigned temporally the solar thermal output to LT or HT.
- Steam- and Hot-Temperature Modeling (SHT): To address temperature peaks, that cannot be covered by solar thermal collectors and thermal storages, a third temperature model were implemented into OptEnGrid. This temperature level can be covered only by biomass heating plants or electric steam generators (P2H).
- Absorption heat pump (ABSHP): The generated LT heat sources should also be raised to a temperature level for the usage in the DHS. For this reason, a further technology – the absorption heat pump – was implemented into the optimization. This technology is able to generate HT heat driven by an SHT heat input and a LT heat source.

Since the amount of biomass was to be kept low and P2H is an expensive energy source for the operation of ABSHP, the impact of new implemented technology was limited. As a result, our partner *Savosolar* simulated a combination of flat-plate and parabolic tube collectors, so that the solar output always had the desired HT flow temperature by reduced efficiency. The solar thermal generation profile was integrated into OptEnGrid and an optimization calculation was made for Helsinki's DHS.

Energy Research Program – 3rd Call

Climate and Energy Funds of the Federal Government - handled by the Austrian Research Promotion Agency (FFG)

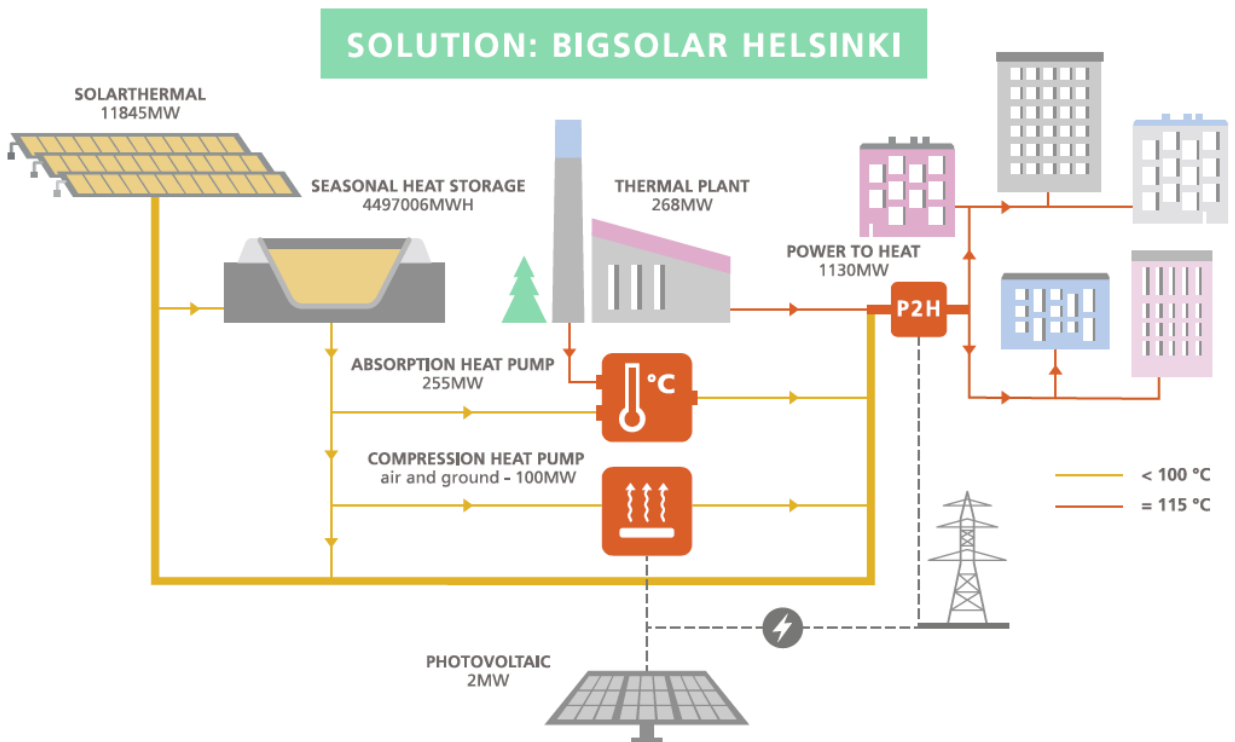

Figure 23: Technological concept of Helsinki's energy system for cost and CO₂ reduction.

Based on the concept, levelized costs of energy (LCOE) of 37 €/MWh could be calculated, which represents also a CO₂ reduction of 98% compared to the existing system with LCOE 54 €/MWh. The results are shown in Figure 24.

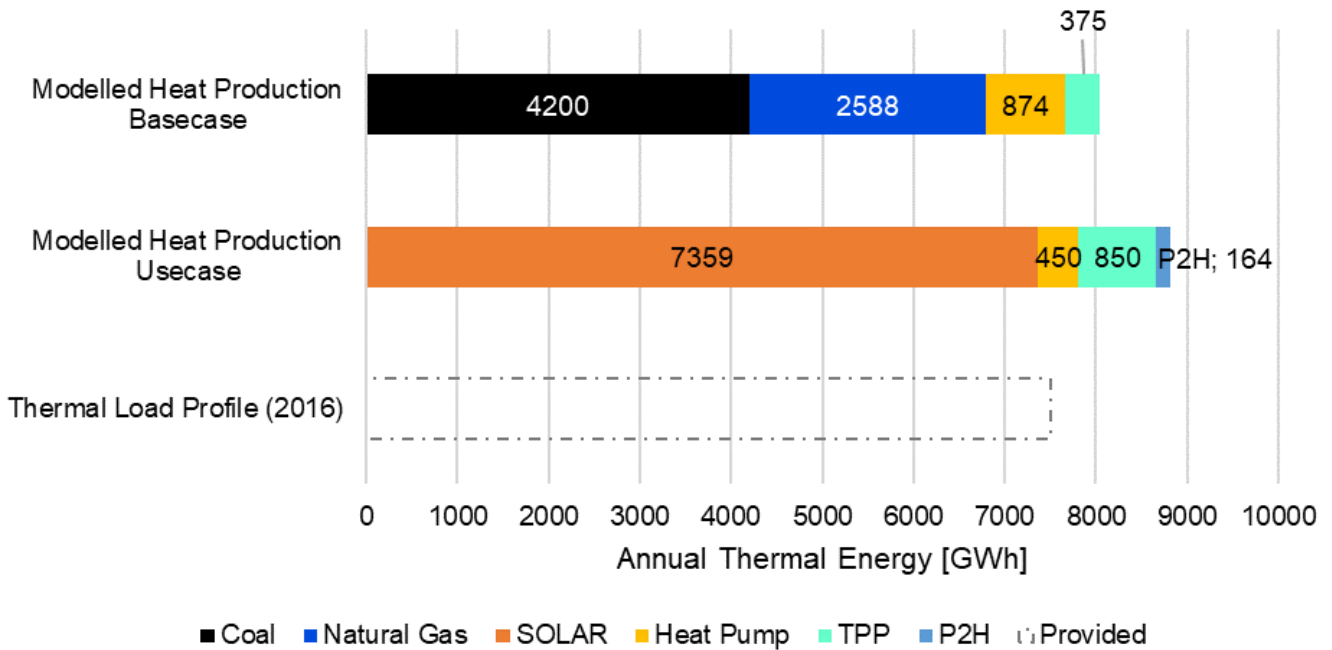

Figure 24: Existing and modeled energy supply of Helsinki's district heating network using OptEnGrid.

3.2.6 Validation of the Solar Thermal Model

In the use case of SOLID, the solar thermal yields calculated by OptEnGrid were validated. The objective was to compare solar thermal yields predicted by OptEnGrid with real measured solar thermal yields.

OptEnGrid predicted solar thermal yields based on Meteonorm data cannot sufficiently be compared to real measured solar thermal yields. The difference of Meteonorm climate data and weather data lead to high differences in annual yields. This detected difference has high significance on the accuracy of OptEnGrid solar thermal yield prediction. Consequently, a SOLID plant was chosen, where global and diffuse irradiation as well as ambient temperature was measured [16]. This set up guaranteed a comparison of outputs, based on the same irradiation inputs. The monitored collector array is equipped with volume flow, return and flow temperature sensors, which allows to calculate the thermal power output. For precise input data, high-precision measurement of solar radiation, both total tilted radiation and beam/diffuse radiation is important. For this purpose, a pyranometer in the collector plane and a pyranometer, mounted on a sun-tracker are used.

Global and diffuse irradiation and ambient temperature were measured inputs for the OptEnGrid-solar thermal yield prediction. The available area was the constraint and the maximal power of the load was factor 2 higher than the maximal solar thermal power. In the configuration of OptEnGrid, the auxiliary energy was defined by a gas-driven heating plant to fulfil energy balances. The hourly solar thermal yields were compared to the corresponding measurement data from the heat meter. The validation process from input data via OptEnGrid calculation to validating the results is shown in the Figure 25.

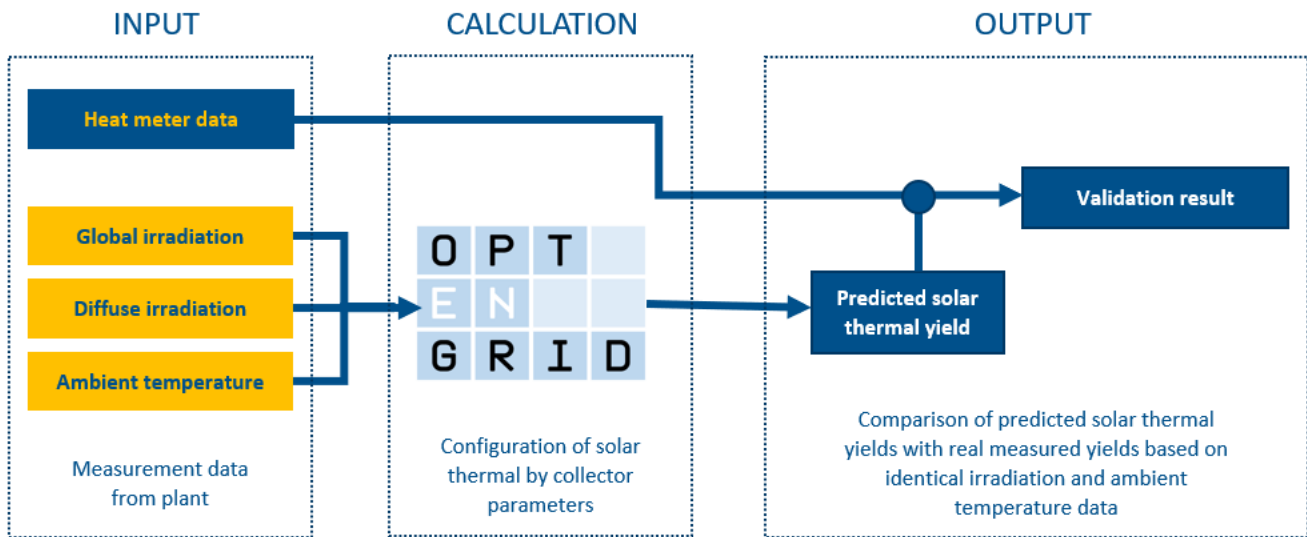

Figure 25: Methodology of the predicted solar thermal yield validation.

OptEnGrid is predicting annual solar thermal yields for this plant at 245MWh. This is 26% higher than measured data (193MWh) have shown. The following table show this result:

Energy Research Program – 3rd Call

Climate and Energy Funds of the Federal Government - handled by the Austrian Research Promotion Agency (FFG)

Table 8: Comparison of measured solar thermal yields and OptEnGrid-predicted yields.

	Solar thermal yield	Deviation
Heat meter data	193MWh	-
OptEnGrid yield prediction	245MWh	+26%

To evaluate this difference in solar thermal yields, specific days were analyzed in detail. Six typical yields per day within the four seasons are shown in the Figure 26. The OptEnGrid solar thermal yields start earlier than measured data do – the entire curve seems to be shifted up to two hours to the left. The reason might be the threshold of irradiation, when OptEnGrid expects solar thermal yields. Typically, this behavior is observed, when the threshold is defined at about 50W/m² - this threshold is realistically at about 250W/m². Additionally, the return temperature levels have a significant impact on the start of solar thermal operation.

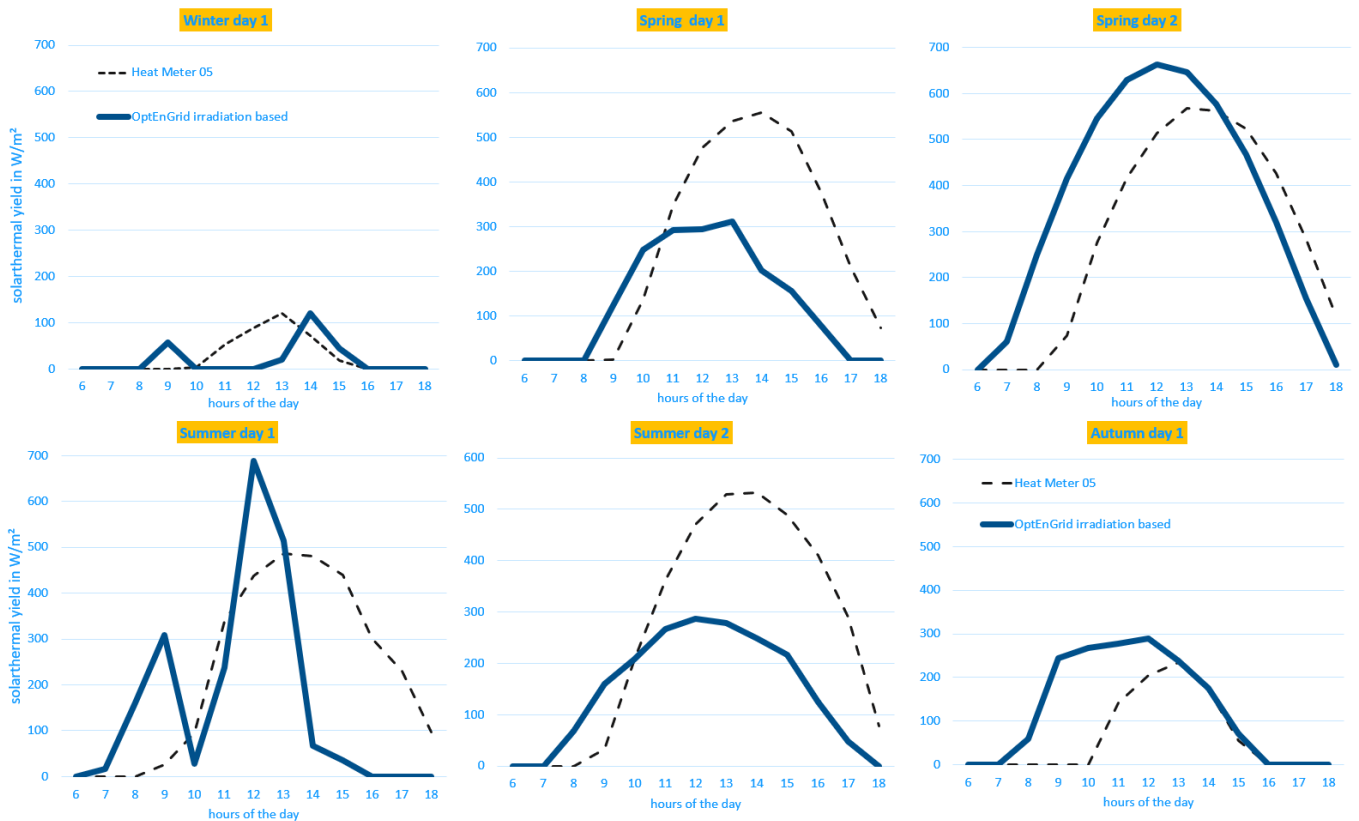

Figure 26: Comparison of measured solar thermal yields and OptEnGrid-predicted yields.

Comparing specific predicted solar thermal yields with their corresponding measurement value has not shown any systematic over- or under estimation of OptEnGrid. This evidence is shown in the Figure 27. The x-axis OptEnGrid represents predicted daily solar thermal yields and the y-axis represent at this timestamp the corresponding measured daily solar thermal yields. As the values be located on the diagonal straight line, predicted, and measured value are the same. Values be situated within the range of the dotted line, a +/-10% deviation of the measured data is detected.

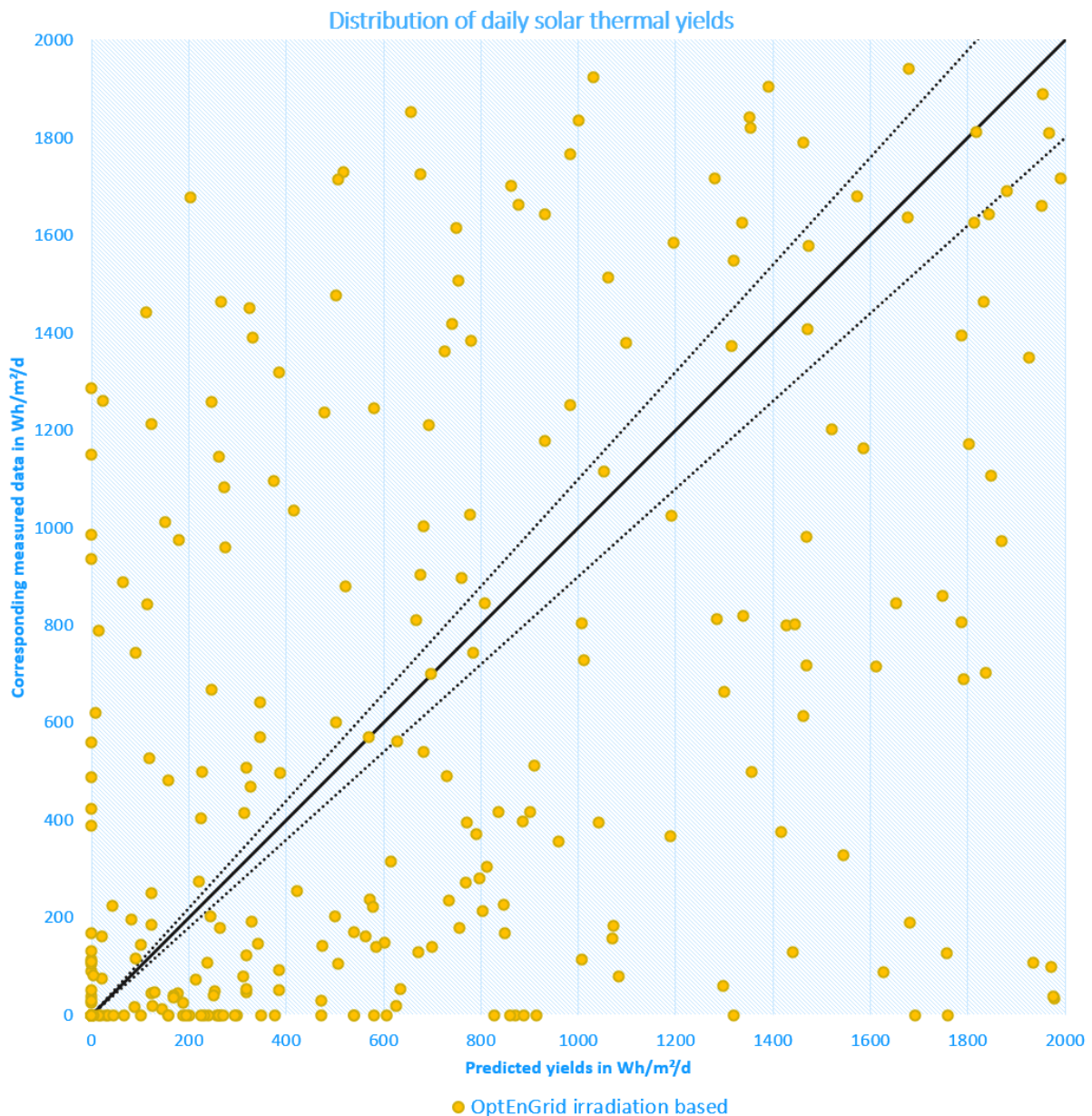

Figure 27: Distribution of daily solar thermal yields.

The values in this figure are located all over the graphic in a diffuse cloud. As a consequence, no conclusion can be derived on the prediction performance on days with higher or lower solar thermal yields.

3.2.7 World Direct (WD)-Building

In the use case of the World Direct building (WD building), the optimal use of renewable technologies was to be dealt in a small-scaled energy system. The use case was chosen because two new buildings for office purposes and company apartments were built next to the existing office building of World Direct eBusiness Solutions GmbH during the project. Regarding the previously existing building, energy demands, building characteristics and installed technologies of the existing building were analyzed in order to prepare the use case.

The planned technologies in the two new buildings consisted of electric-driven hot-water storage, floor heating or cooling systems for conditioning (heating and cooling) via air-sourced heat pumps with heat storage and two PV systems at each roof. The thermal storage is available for room heating during the heating season and is supposed to be a sensible cold storage during the summer. For this reason, the investment costs of the cold storage were neglected, see table below, as they are already considered in the design of the heat storage. The heat pump *iDM Terra AL 24* with a maximum output of 24 kW_{th} can be controlled for both space heating and cooling. The *Coefficient of Performance* (COP) was analyzed from the data sheet according to the manufacturer and a simplified modeling was implemented in OptEnGrid based on the ambient temperature (T_{AMB}). The model considers a fixed term (COP_{fix}) and a variable ambient temperature-based term (COP_{var}) to involve the correlation of outside temperature and heat pump efficiency. It is given by eq. (35).

$$COP = COP_{fix} + T_{AMB} \cdot COP_{var} \tag{35}$$

The efficiency of the planned heat pump was converted to an ambient temperature of 0°C and create a fixed COP of 4.135 (A0/W35) and a variable coefficient of 0.1064 for heating operation. Simultaneously, the cooling capacity was A35/W18 with a fixed *Energy Efficiency Ratio* (EER) of 3.89 and a variable EER of 0.05. The costs for all technical systems were taken from company offers and data from literature, see Table 9 below.

Table 9: Specific investment costs used to determine optimal capacities using OptEnGrid.

Technology	Unit	Specific Investment Costs
Photovoltaic	€/kW _p	1230
Air Source Heat Pump	€/kW _{el}	5960
Heat Storage	€/kWh _{th}	95
Cold Storage	€/kWh _{th}	0
Electric Storage	€/kWh _{el}	610

On the basis of energy certificates and the energy data of the existing building, the following energy consumptions could be assumed for the newly planned buildings:

- Electricity Demand: 47,606 kWh_{el}/a
- Hot-Water Demand: 1,360 kWh_{th}/a
- Space Heating Demand: 27,813 kWh_{th}/a
- Space Cooling Demand: 5,046 kWh_{th}/a

In the Optimization, the electricity demand profiles were based on the measured data of the existing building. For space heating and hot water, synthetic profiles from literature [17-19] were used and scaled with the calculated energy demand. To determine the cooling demand profiles, a data analysis of the existing building was performed and adapted to the cooling demand of the new buildings. As one building also incorporates five apartments, this was also considered by using weighting factors in relation to the personnel capacity of the building. In the optimization use cases, the fixed size of the PV was removed, and an optional battery storage was allowed. With the help of *World Direct eBusiness Solutions GmbH*, it

was determined that an expansion of the PV system by approximately twice the installed capacity would be possible, as sufficient roof space was available.

The optimization scenario showed an advantageable expand of the PV system by 11 kW_p. This resulted especially from the simultaneity of generation and consumption. The PV electricity was produced during the day when there was sufficient solar radiation and can also be used directly in the office building to a large extent. Similarly, the electricity demand of the heat pumps was aligned with the production, as the same phenomenon occurred on the thermal section and the optimized control system takes advantage of the PV output. Without intelligent control, the operation of the heat pump is approximately directly based on the heat demand and the required electricity would be purchased to the utility grid which would lead to higher costs and CO₂ emissions by higher grid dependency in times of missing solar output. Despite low electricity costs of commercial operation, a PV system demonstrates enough profitability for reasonable use.

The doubling of the PV system presents a 2.5 % reduction of the annual energy costs in combination with an intelligent control and additionally causes a reduction of 13.9 % of the total annual emissions. The optimization did not suggest a battery system in this case. This was further investigated in a parameter analysis. Only at a price threshold of 250 €/kWh_{el}, an economical operation of a battery occurred. This result was again justified by the high concurrence of generation and consumption, whereby no potential for load shift management was identified, but a thermal symbiosis of PV, heat storage and heat pump led to flexibilities. The results are given in the Table 10.

Table 10: Results based on cost representation using optimized technology design.

	Parameter	Unit	Reference	Optimization	Difference
Costs	Annual Costs	€/a	16,685	16,267	- 418
	Operational Costs	€/a	9,682	8,387	- 1,295
	Annual Capital Costs	€/a	7,003	7,880	+ 877
	Sales from Feed-In	€/a	7	92	+ 85
CO₂	Annual Emissions	t_{CO2}/a	13.97	12.02	- 1.99
Portfolio	Photovoltaic	kW _p	10	21	+ 11
	Battery	kWh _{el}	-	-	-
	Heat Pump	kW _{th}	48	48	-
	Heat Storage	kWh _{th}	9	9	-
Balance	Electricity Generation	kWh _{el} /a	10,987	23,031	+12,044
	Electricity Import	kWh _{el} /a	61.454	52.076	- 9.378
	Electricity Sales	kWh _{el} /a	208	2.897	+ 2.689

In the following Figure 28, two operating modes are compared based on the electricity balance of a representative calendar week from 06.05.-12.05.2020 (Monday-Sunday). It should be noted that the PV

system size varies and is therefore calculated with 10 kW_p in the reference case and with 21 kW_p in the optimization case.

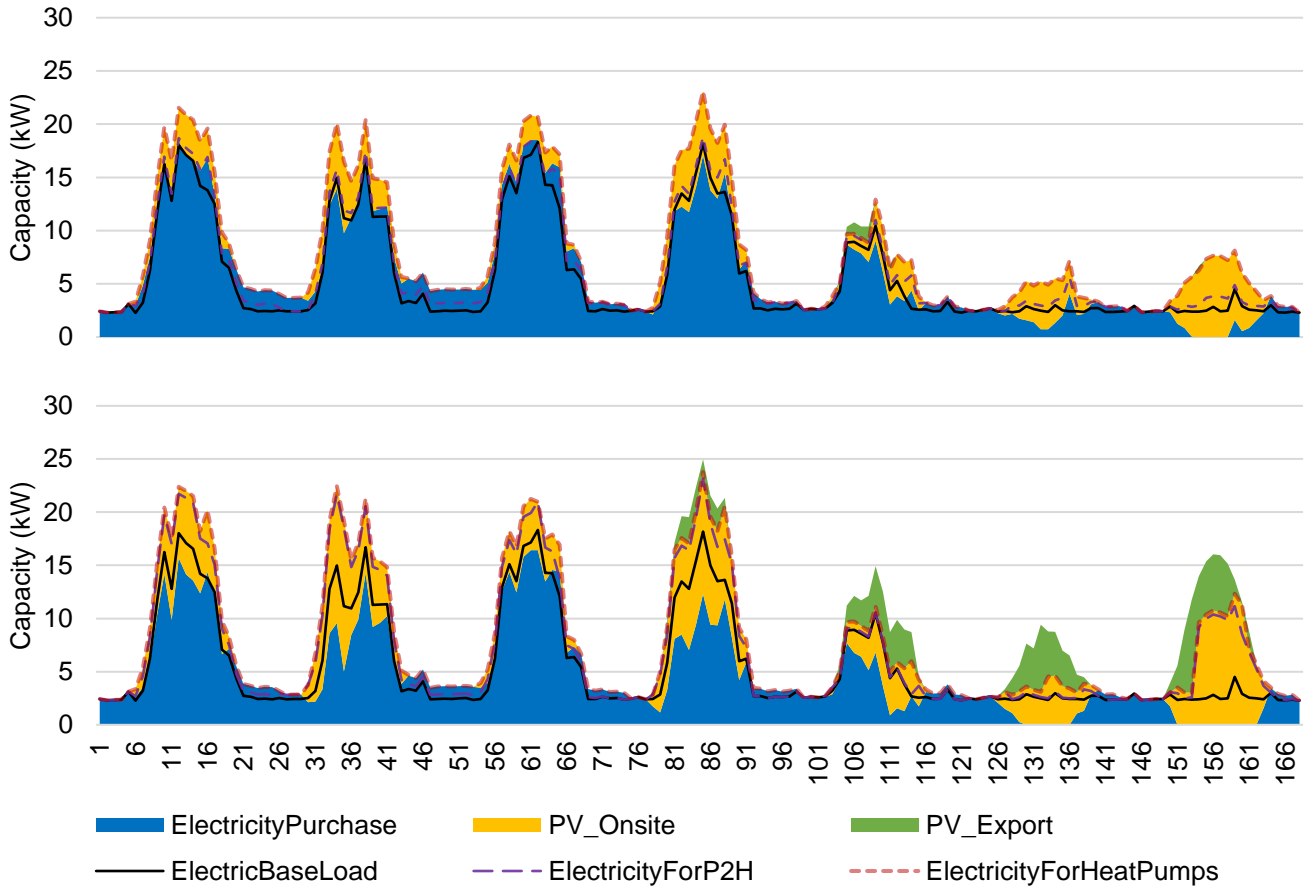

Figure 28: Electricity demand, generation and sales related to the reference case (top) and optimization case (bottom).

3.2.8 Boiler Pool

The boiler pool presented 20 electric hot water boilers installed in two multi-family houses (MFH) with around 20 apartments. The data of the individual boilers (supplied by the project partner *World Direct eBusiness Solutions GmbH*) provided information about temperature levels of three measurement points per boiler, the average temperature of them and the amount of energy stored in the boiler, as well as the electrical operation from hot water heating system by heating elements (named in the optimization: power-to-heat or P2H). The goal of the test case was to identify load shifting potentials in order to make optimal use of the volatile power generation from two PV systems on the roof of the MFH.

The technologies listed below were parameterized for optimization. The generation profiles of the two PV systems were determined on the basis of irradiation data from *Meteonorm 7.3* [4]. The P2H were already able to be used for experimental purposes on the intraday and spot market in real cases and could be controlled in a modellable operation. Based on the corresponding, researched tariff of the utility and the semi-annual report on electricity price development of E-Control [20], the night and daytime tariffs were embedded in the optimization. With the help of the real measured data, the boilers were mainly charged with cheap night-time electricity in the reference case and the discharge during the day only took place

Energy Research Program – 3rd Call

Climate and Energy Funds of the Federal Government - handled by the Austrian Research Promotion Agency (FFG)

when there was an increased demand of hot water. Considering heat losses and the non-coupled solar output, this operation ensures low efficiency, high energy costs and reduced self-consumption of the PV-generated electricity. The technologies to optimize the boiler pool are given in Table 11.

Table 11: Technologies to optimize the boiler pool.

Technology	Amount	Capacity (kW or kWh)	
		Per Apartment	Total
Heat Storage	19	4.5	92.0
	1	6.5	
P2H	19	2.5	50.7
	1	3.2	
Photovoltaic	2	24.7	49.4

Unified electricity load profiles for households were created for the electricity loads caused by the heating elements. For this purpose, the *LoadProfilGenerator* was used to create [21] nine profiles for households of different composition and demographics (family, single, working, unemployed, young, old, etc.) and those were scaled to a unified profile and summarized with an annual electricity demand of 3,451 kWh/a per household. The consumption and generation profile of the PV system, as well as captive demand, sales, and grid purchases, are shown in the figure below for the reference case. The operation present peaks – caused by the P2H – in the night thus electricity generation and consumption diverge and cheaper PV electricity is sold. These results are shown in Figure 29.

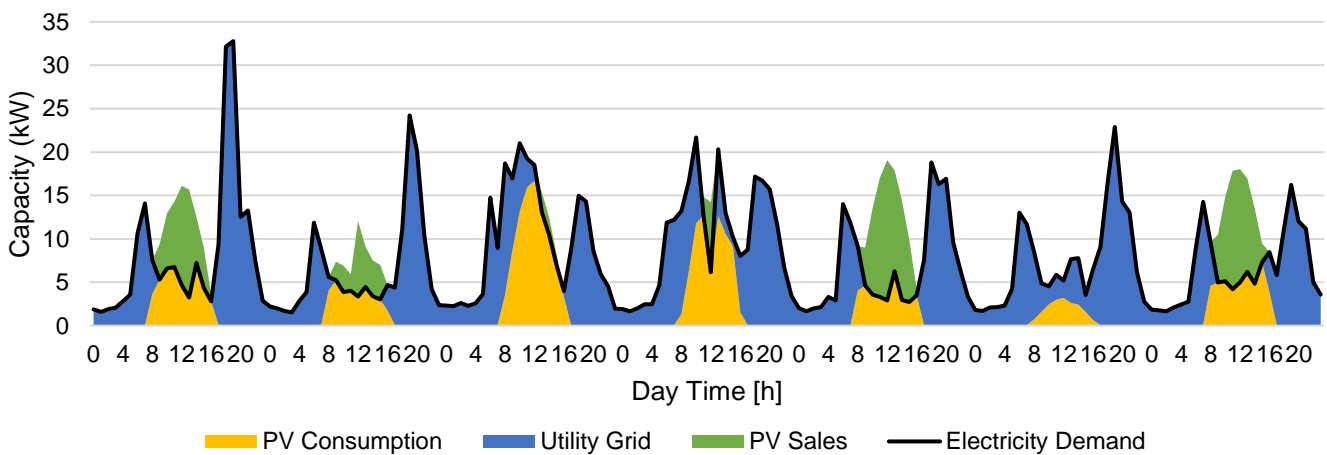

Figure 29: Profiles of electricity demand, self-consumption, sales and import via utility grid for the reference case.

In the optimization, the operation of P2H based on the real measured data was neglected, and OptEnGrid should determine the most cost-efficient operation based on all economic aspects. As an example, the thermal operation of one boiler is presented in the graphs below for both reference and optimization cases. A clear difference is visible in time steps of charging. While in the reference case the boiler was loaded during the night tariff period, the optimization shifted the charging procedure to the end of this tariff period in the early morning in order to keep heat losses as low as possible. Furthermore, the available PV electricity is mainly used to charge the boilers to use low electricity costs by solar output in the optimization. In the same manner, the concurrency between generation and consumption led to reduce the stored heat outside of PV production times and leads to less heat losses. The optimization case showed another

advantage of the smart controller by forecasted consumption data and renewable generation. Stored heat was reduced, which minimized heat losses again and ensured economically optimal operation. In parallel, the emissions generated were reduced too by less utility grid dependency. These results are shown in Figure 30.

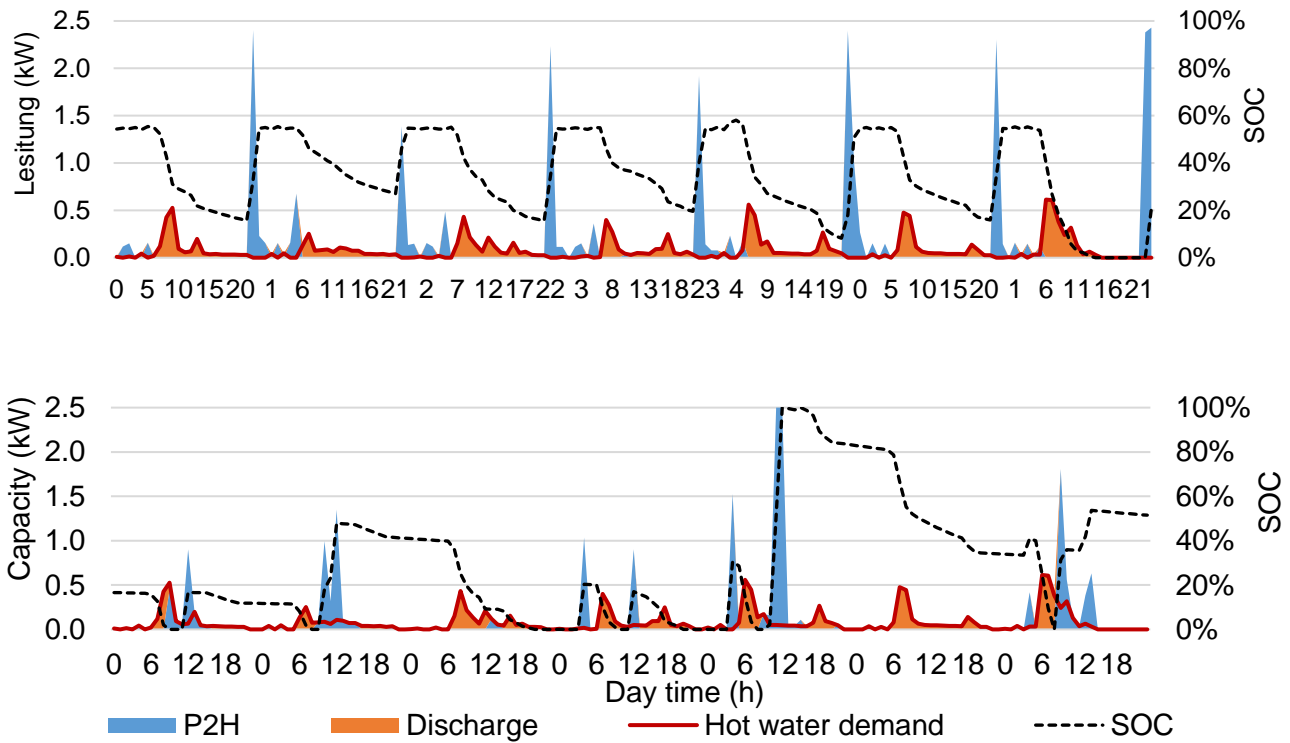

Figure 30: Thermal operation of an exemplary boiler for reference (top) and optimization case (bottom).

The operation of the exemplary boiler is visible in the aggregated electricity profiles, see graphs in Figure 31. In contrast to the reference case, the operation of P2H seems smoother. The lump-shaped course of the electricity demand of the heating rods already indicates an increased use of the PV electricity. In this scenario, the self-consumption share could be increased from 53.9 % to 78.1 % and the grid consumption could be reduced by 17.7 %.

Energy Research Program – 3rd Call

Climate and Energy Funds of the Federal Government - handled by the Austrian Research Promotion Agency (FFG)

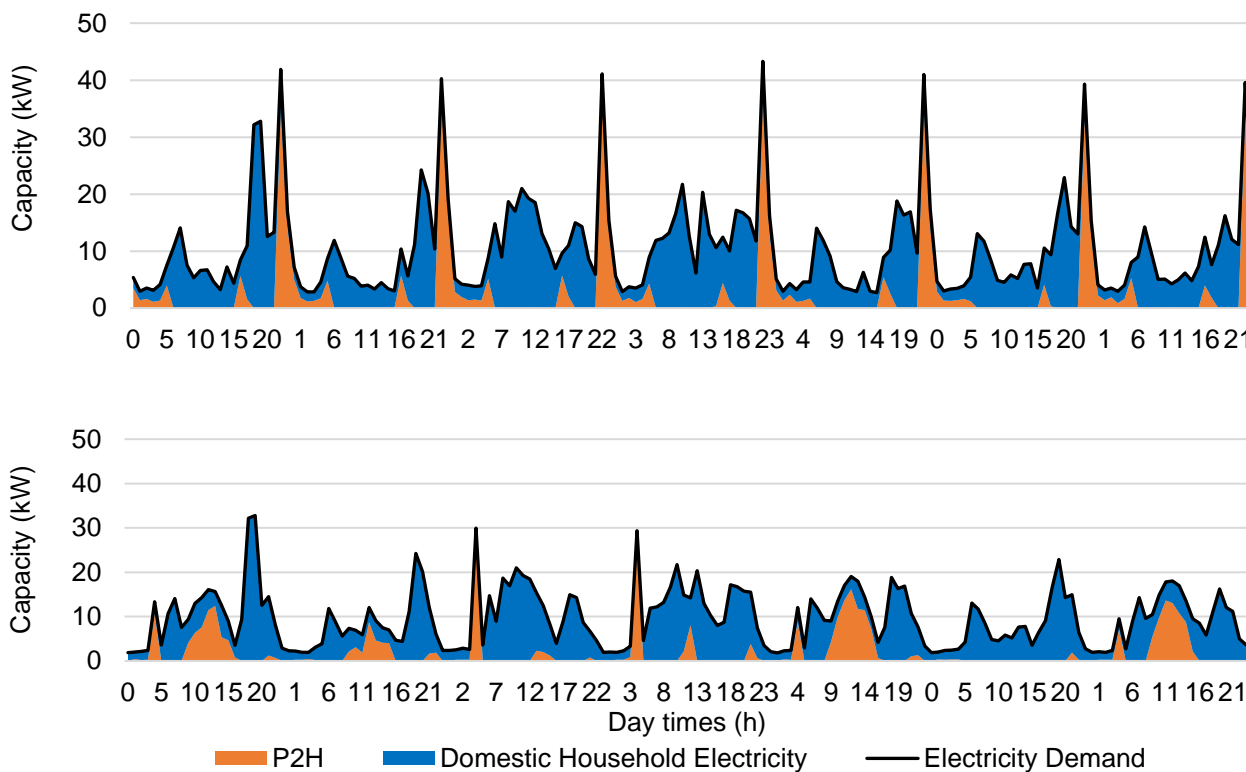

Figure 31: Electricity operation of P2H and domestic household electricity for reference (top) and optimization case (bottom).

Since the sales of PV electricity in this use case brought only minor economic benefits, the surplus was instead converted into heat via P2H and stored in the boilers. During summer months a more equal balance between sales and storage existed due to higher solar output.

In summary, the intelligent control of the boiler pool demonstrated significant reductions based on annual energy costs of 19.2% and savings of 27.1% in annual emissions. Considering a 20-year period, this would result in reductions of roughly € 62,000 and 81.6 t_{CO2} emissions, excluding investment and maintenance costs of the electric boilers.

4 Results and Conclusions

Within the OptEnGrid project a very comprehensive optimization tool has been designed that can handle many different use cases on the electrical, heating, and cooling sectors. The major features of the Mixed-Integer Linear Programming (MILP) framework include the modelling of seasonal effects for e.g. solar thermal systems, non-linear effects, innovative hot water storage models, as well as new technologies as hydrogen and renewables. The mathematical setup allows the user to model cross-sectoral energy systems as well as Microgrids with multiple nodes (up to 20 nodes). The methodologies have been demonstrated in ten different use cases, eight described in detail in this report. Solar thermal, heat storage, central heating, PV, Wind, hydrogen, fuel cells electric vehicles, Combined Heat and Power (CHP), heat pumps, boilers, absorption heat pumps, and P2H technologies concepts have been designed and evaluated. Cost and CO₂ minimization objective functions have been considered and delivered optimal investment capacities as well as optimal operational schedules. The results have been tested, especially on the thermal side by our project partner SOLID and one design has been already implemented – the TFZ Microgrid testbed. That testbed is also used for Model Predictive Controller (MPC) development and directly leads to improvements to the OptEnGrid planning tool. Through the use-cases, deficiencies have been detected and resolved. For example, the Helsinki Energy System project allowed the team to remove challenges in the heating balance of the MILP optimization and also led to additional work and improvements to allow OptEnGrid to model large energy systems with multiple temperature levels (though no direct temperature tracking was achieved).

Future possible work can include Regional Energy Community modelling, which would allow for energy sharing between multiple houses. Some of that work has been already started in other projects, but critical pieces are still missing. For example no CHP or wind is currently considered in the basic REC work. During the project it became clear that an efficient multi-year optimization framework will be needed that allows for modelling changes in e.g. tariffs, technology assumptions, or regulations. Such a framework will need to focus a lot on run-time efficiency since initial tests have shown that such a multi-year approach can run for several days with the current MILP formulation. To solve this problem the team will put a significant amount of research towards this in the future. Finally, the temperature tracking of solar thermal systems constitutes a challenge for MILP models and no temperature enabled planning model exists in the literature to our knowledge. Thus, at this point no temperature profiles or tracking has been implemented for solar thermal or hot water storage systems in OptEnGrid. However, this problem has been recognized by the team and it has already started with the basic research for that topic. A basic concept for a two stage approach already exists and might provide the needed capabilities in the long term.

The outcomes of the OptEnGrid project have led to international collaborations and further projects. The FFG COMET program directly benefits from the research and use-case work and this allows the team to continue and deepen the research. The OptEnGrid work led to a specific COMET project with a California startup company and to a knowledge transfer around the hydrogen modelling. SOLID on the other hand plans to expand OptEnGrid and add user interfaces, which will allow usage of OptEnGrid in their internal sale and design processes.

Finally, following peer reviewed journal publications, conference papers, trade journal articles, as well as master thesis have been published:

- Armin Cosic, Michael Stadler, Muhammad Mansoor, Michael Zellinger: *“Mixed-integer linear programming based optimization strategies for renewable energy communities”*, Energy, 23.July 2021, ISSN 0360-5442, <https://doi.org/10.1016/j.energy.2021.121559>
- Muhammad Mansoor, Michael Stadler, Hans Auer, Michael Zellinger: *“Advanced optimal planning for microgrid technologies including hydrogen and mobility at a real microgrid testbed”*, International Journal of Hydrogen Energy, 8. April 2021, ISSN 0360-3199, <https://doi.org/10.1016/j.ijhydene.2021.03.110>.
- Michael Stadler, *„Anwendungsbeispiel und Planungskonzept auf Basis des zellularen Energiesystems“*, VDE Online Fachforum Planung zellulärer Energiesysteme, 23. Februar 2021, Online
- Mansoor Muhammad, Michael Stadler, Michael Zellinger, Klaus Lichtenegger, Hans Auer, Armin Cosic: *“Optimal Planning of Thermal Energy Systems in a Microgrid with Seasonal Storage and Piecewise Affine Cost Functions“*, Energy Journal by Elsevier, Volume 215, 15 January 2021, ISSN: 0360-5442, <https://doi.org/10.1016/j.energy.2020.119095>.
- Zellinger Michael, Muhammad Mansoor, Armin Cosic, Pascal Liedtke, Michael Stadler: *„Optimization based Planning of energy systems“*, Central European Biomass Conference CEBC, Topic: Decarbonisation of the energy system, oral and visual presentation and proceedings, January 2020, Graz, Austria.
- Aigenbauer Stefan, Stadler Michael, Zellinger Michael, *„100% ein Zukunftsprojekt; Innovatives Forschungslabor am Technopol Wieselburg“*, TGA Jahrbuch 2020; Seite 82.
- Aigenbauer Stefan, Michael Stadler, Michael Zellinger, Christine Mair, Pascal Liedtke, Armin Cosic, Muhammad Mansoor: *„Microgrid Lab – R&D project for decentralized energy supply with biomass and other Distributed Energy Resources (DER)“*, Central European Biomass Conference CEBC, Topic: Decarbonisation of the energy system, oral and visual presentation and proceedings, January 2020, Graz, Austria.
- Lichtenegger K, Unterberger V, Stadler M, Zellinger M, Carreras F, Moser A. *Thermal Trouble: Challenges in Optimization and Evaluation of Thermal Energy Systems. IAPE 2019 : International Conference on Innovative Applied Energy (oral presentation). March 2019*
- Gerardts Bernhard, Klaus Lichtenegger, Manfred Steinlechner, Michael Stadler: *“Energy transition challenges from the thermal energy sector’s perspective,”* EMEASEC 2018, INCOSE EMEA SECTOR SYSTEMS ENGINEERING CONFERENCE, Systems Engineering: Connecting the world, 5. - 7. November 2018, Berlin, Germany.
- Lichtenegger Klaus, Michael Stadler, Andreas Moser, Michael Zellinger, Daniel Muschick, Markus Gölles, Manfred Steinlechner, Tarek Ayoub, Bernhard Gerardts: *“Optimization of Heating, Electricity and Cooling Services in a Microgrid to Increase the Efficiency and Reliability“*, Making Distributed Generation Business Succeed, Electrify Europe, 20 June 2018, Vienna, Austria.
- Stadler Michael, Christine Mair, Michael Zellinger, Klaus Lichtenegger, Walter Haslinger, Margit Temper, Andreas Moser, Elisa Carlon, Daniel Muschick, Markus Gölles: *„Mikro-Netze und die regionale Balance von Erzeugung und Verbrauch im Strom- und Wärmebereich“*, Impulsreferat 20. Österreichischer Biomassetag, Sektorkopplung & Flexibilisierung, Windischgarsten, Österreich, 14. November 2017.; Quelle: https://www.best-research.eu/webroot/files/file/MikronetzeV12_Internet.pdf
- Liedtke Pascal, Franz Hengel, Michael Stadler: *“Simulation von Kosten und CO_{2eq} reduzierenden Energieeinsparungen eines Microgrids anhand einer mathematischen Optimierung”*, Masterarbeit, Fachhochschule Pinkafeld, Österreich, 1. August 2020
- Liedtke Pascal, Michael Stadler, Michael Zellinger, Franz Hengel: *“Ganzheitliche Planung dezentraler Energiekonzepte durch mathematische Optimierung”*, e-nova Konferenz, Pinkafeld, Österreich, 12 - 22. November 2019

Energy Research Program – 3rd Call

Climate and Energy Funds of the Federal Government - handled by the Austrian Research Promotion Agency (FFG)

Oberbauer Christian, Franz Theuretzbacher, Michael Zellinger: *“Optimization of Renewable Based Microgrids – Use Case Lower Austria”*, Masterthesis, Fachhochschule Wiener Neustadt – Campus Wieselburg, 4. September 2020

5 Outlook and Recommendations

This section contains the future outlook and recommendations that can be envisioned as the possible extension of the modelling framework that has been developed in this project. The current modelling framework is ultimately viewed as basic building block over which future models such as renewable energy communities, planning of electric vehicle infrastructure, multi-year optimization scenarios, detailed temperature modelling in heating technologies and different real-life test cases can be realized. These possible extensions are briefly summarized in following sub-sections.

5.1 Renewable Energy Communities

In order to further promote decentralized energy supply and strengthen regional supply concepts, Local or Regional Energy Communities (REC) receive increased attention in Austria. Energy communities are going to be legally defined in an amendment to the „Elektrizitätswirtschafts- und Organisationsgesetzes“ (EiWOG) [22] (“Electricity Act 2010”) and anchored in the „Erneuerbaren Ausbaugesetzes“ (EAG) [23] (“Renewable Energy Expansion Act”). According to EAG §74 paragraph 1, a REC can produce energy from renewable sources and consume, store or sell the energy. Therefore, for each community member it will be possible to exchange energy from renewable sources (such as PV, wind power stations, combined heat and power systems, fuel cells and energy storage systems) within the defined community. The membership is open to private individuals, small and medium-sized enterprises (SMEs), public authorities (including municipalities), climate and energy model regions, e5-communities and tourism regions.

To create a financial incentive for the participants, a reduced grid tariff will be introduced for the electricity exchanged within the REC, as well as other financial advantages such as the partly cancellation of charges (electricity levy, green electricity subsidy, etc.). Thus, this new option for the renewable energy transfer between the community members (nodes in OptEnGrid) combined with the newly introduced time-of-use pricing rates have to be considered in the modelling and optimization-based planning of energy communities. Therefore, the current OptEnGrid MILP model will be extended so that the additional operational decisions with respect to a large number of distributed energy resources (i.e. PV, wind, combined heat and power systems) and energy transfer within the community are also considered in the optimization.

In this case, the optimization can be performed from the perspective of the operators of the REC, and therefore, according to the community total costs. To accurately reflect the new cost components within an energy community, two new cost variables have been added to the original cost objective function (more precisely to the $C_{utility}$ variable):

1. Electricity sales from the participants with a power source to the community. In this case, a participant can sell its e.g. PV surplus electricity to the community at a certain (hourly based) price if a power demand exists, otherwise it can be sold to the grid.
2. Purchasing the surplus electricity of the REC members at a reduced (hourly based) community tariff.

Energy Research Program – 3rd Call

Climate and Energy Funds of the Federal Government - handled by the Austrian Research Promotion Agency (FFG)

Moreover, for each participant (node) a separate electrical utility cost $C_{utility_{node}}$ is introduced in order to consider different time-of-use tariffs and monthly/yearly demand charges of the electricity purchased for each participant explicitly. Considering these additional enhancements to the modelling of REC, the total annual energy costs per node C_{node} can also be determined. Thus, in order to avoid higher individual costs for each participant (node) in a community constellation, each node gets a boundary condition, so that the individual costs in the REC are not exceeding the individual reference costs $C_{reference_{node}}$ as given in eq. (36).

$$C_{node} \leq C_{reference_{node}} \tag{36}$$

Furthermore, the transfer of surplus energy to a specific node can be limited by setting the maximum amount of energy purchase out of the community. This is especially necessary in case of different electricity prices, since the costs can drive the optimization regarding economic criteria. An example of the energy communities modelling in OptEnGrid with a central energy storage system is shown in the Figure 32.

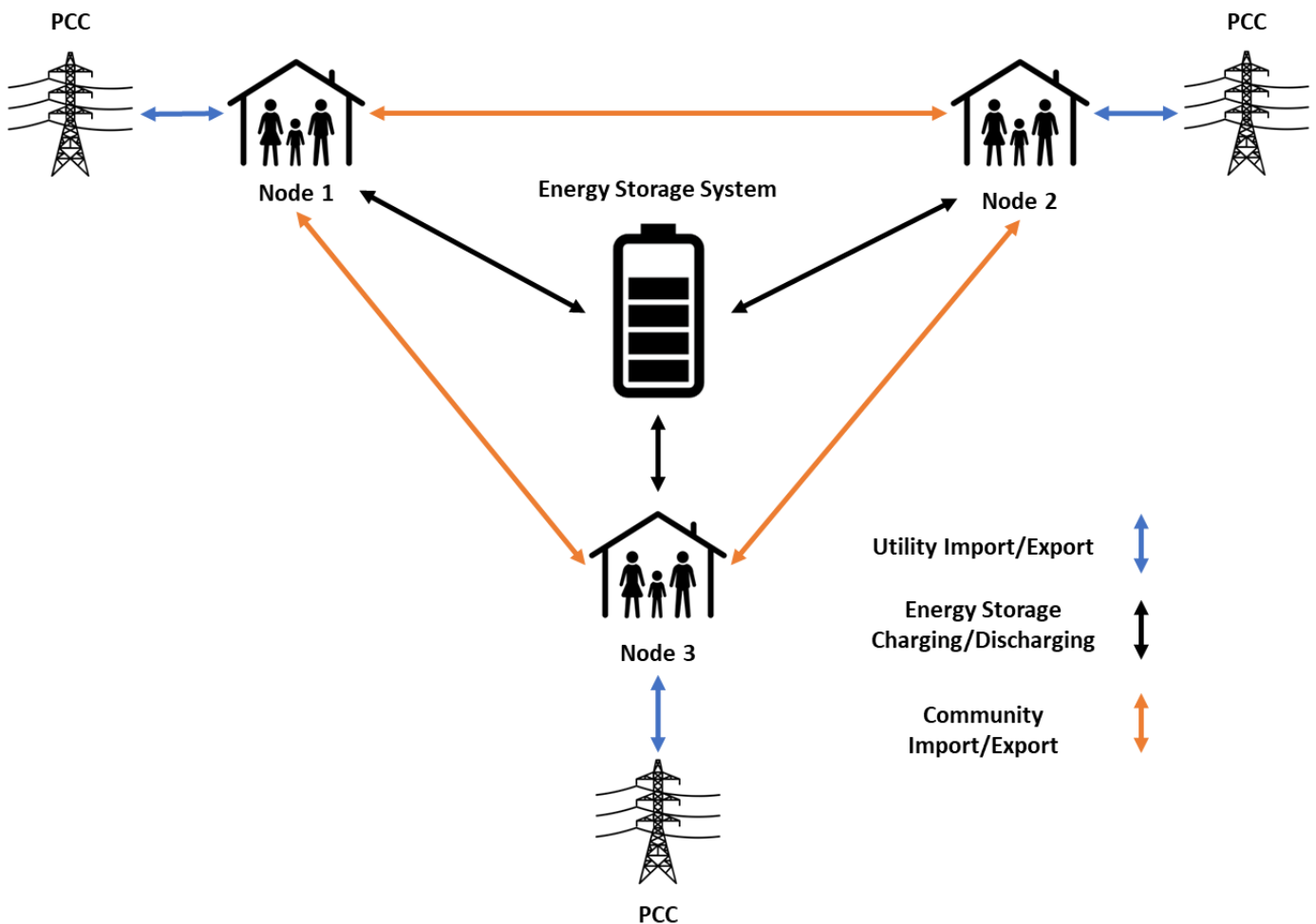

Figure 32: Central energy storage based energy community model with three community participants

5.2 Electric Vehicles and EV Charging Infrastructure

Currently, electric vehicles (EV) exist as a continuous technology in the OptEnGrid code. Although, testing in the WD Building use case (see sub-section 3.2.7) has shown that the EV model should be enhanced by adding further details. This modification would affect the technological implementation itself, as well as economic and environmental aspects. Possible extensions to the current EV model could consist of the EV's technological properties or the driver's behavior, e.g. the distinction between EV's that are V2G (Vehicle-to-Grid) ready and capable to act as a unit for bi-directional charging, or the charge-only behavior which refers to the present situation. On the other hand, the consumer behavior affects the actual capability of the vehicle directly – the current EV model only respects “general” parameters that are possibly suitable for the optimization of future sites, but it is not that applicable for existing use cases which results from e.g. the consideration of home charging tariffs and emissions that are outside the microgrid boundary – therefore binary variables to enable/disable such behavior could be introduced in future. Furthermore, due to high differences between EV's itself, preferences of the drivers and the related interconnection, the model could be possibly extended by giving the opportunity to adjust parameters for each individual EV like the battery size, charging behavior, required SOC when leaving the charging site, time-slots for charging (e.g. arrive at 13:00, leave at 15:00), V2G readiness, investment cost, and so on. Additionally, charging profiles on the base of load profiles in 8760 hours should be considered when extending the EV model.

On this basis, the related electric vehicle charging infrastructure should be considered as a new technology to distribute the generated energy along the electric vehicles. A distinction between AC and DC charging, charging speed and related capacities should exist therefore. Also, the maximal usage for charging with renewable generated energy should be focused to minimize the CO₂ footprint of EV's – and therefore the interconnection with renewable generators such as PV, Wind, etc. and storage technologies as of Stationary battery storages is of importance.

In this scenario, the charging infrastructure needs to be considered in means of investment decisions as well, including fixed and variable costs for the installation, as well as maintenance costs for the operation. Furthermore, additional tariffs could be added for EV Charging, and possible economic benefits for V2G-ready cars that lower that tariff by providing a load shift potential. In addition, fees for operating the charging infrastructure could be considered.

In the same manner, the energy flow modelling concept should be extended to respect the boundaries of technical operation, which especially affects the power flow model. To consider the power flows required for EV charging, Figure 33 displays the load curve for three exemplary charging speeds.

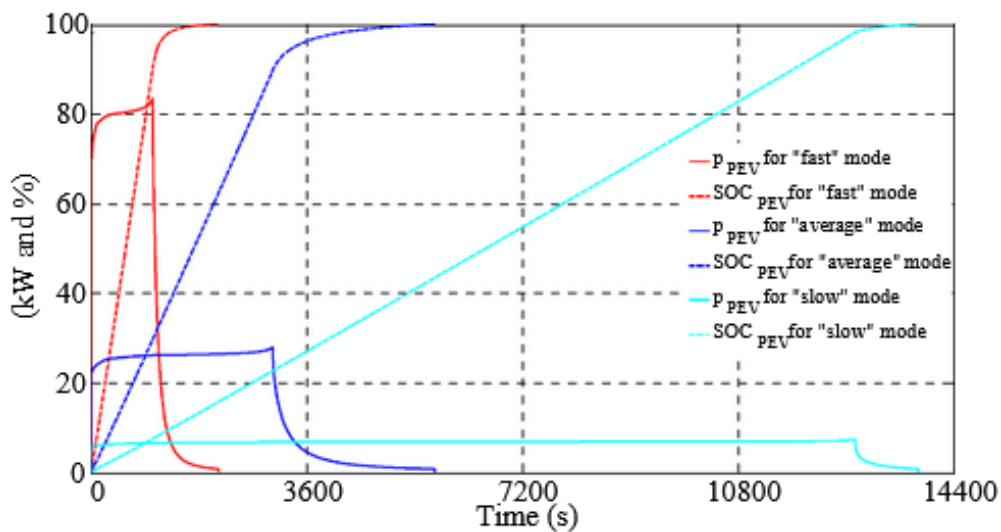

Figure 33: Exemplary EV charging diagram [24]

5.3 Multi-Year Optimization

The current modelling framework of OptEnGrid considers optimization based on a single typical year and then provides investment decisions of the DER technologies for a planning horizon that ranges around 20 years. This modelling framework can be expanded to include an additional layer of time in terms of years to make it a multi-year optimization. The multi-year optimization will provide the minimization of total annual energy costs and total annual carbon dioxide emissions for the selected multiple year timeline and provide incremental investment decisions of DER technologies spread over multiple years which is quite different than current approach.

Also, possible changes in market conditions such as the energy tariffs, economic parameters of the technologies, technical parameters of the technologies and the end-use demands in several upcoming years can be predicted by forecasting methods before-hand to get optimal planning of such systems in multiple year timeline. The forecasting methods to prepare this multi-year input data are critical component of this type of optimization where minimal prediction error is preferred to make the optimal planning more accurate over the future years.

5.4 Temperature Modelling in Heating Technologies

The temperature level is more important for detailed modelling of heating technologies such as solar thermal, heat storage, and heat pumps etc. and have been getting interest from different partners for this kind of modelling. The current OptEnGrid modelling framework considers the heating technologies with an input temperature range as parameter for LT and HT. The variation of the temperature inside the thermal energy technologies does not have any impact on the system performance and decision making for the optimization tool. This modelling framework can be expanded by making temperature as decision variable that can be tracked inside the optimal planning and operation of the heating technologies. Different segregations can also be realized by defining different temperature level variables such as low level, high level and super high level for different technologies.

The main outcome of this additional modelling would provide more detailed planning and operation of heating technologies such as solar thermal, heat storage and heat pumps where temperature plays an important role in the design and operation. Not only the temperatures inside the technologies can be modelled but also the ambient temperature that can affect the operation of certain technologies such as solar thermal. This important addition can be beneficial where temperature tracking is also required for decision-making in the optimal planning of heating technologies in microgrids. The addition of the temperature tracking in OptEnGrid model will significantly improve the optimization tool in terms of effectiveness, making it more usable for customers who are more interested in knowing about temperature variation and its effects on their energy system. A possible simple model for the solar thermal and single temperature based heat storage technology is provided in the Figure 34 for modelling reference of the temperatures of solar thermal (T_h^{ST}) and temperature of heat storage (T_h^{HS}) over hour h .

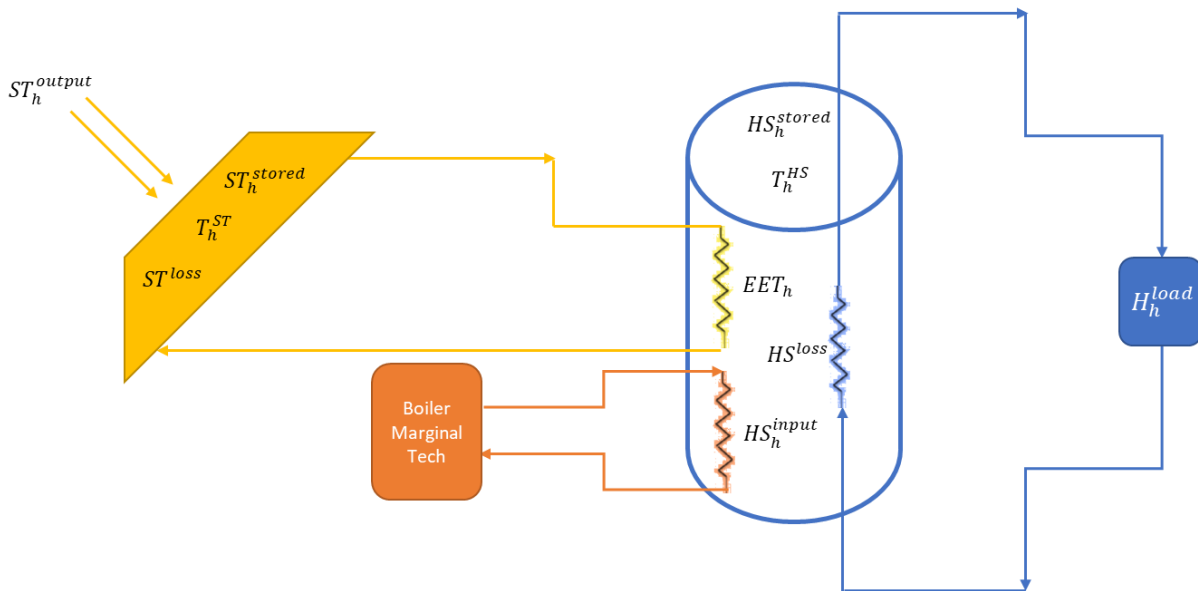

Figure 34: A solar thermal and heat storage with temperatures as decision variables for MILP model.

5.5 Land Use Parameters and Constraints

The main motivation of these land use parameters and constraints (the preliminary modelling is provided in sub-section 3.1.6) is that these building stocks have a finite space where a house or a building can be built and then for planning a microgrid, the space is also limited for certain technologies such as solar PV, solar thermal, battery storage, hydrogen storage, heat pumps and central heating etc.

The preliminary model can be integrated with enhanced Geographic Information System (GIS) to consider different geographical locations and their area limits automatically. It can also provide standardization approach for both designing different building stock options (residential and non-residential) and microgrids together in a single optimization tool. With the proper modelling of these space parameters and constraints and also taking into account the costs associated with these space limits for both buildings and DER technologies, the optimization model can benefit from these important factors and the impact of these

Energy Research Program – 3rd Call

Climate and Energy Funds of the Federal Government - handled by the Austrian Research Promotion Agency (FFG)

parameters can be analyzed as compared to a model which does not constitute these space parameters and constraints. Also, the land use parameters and constraints for primary fuels such as biomass, biodiesel, gas and gasoline etc. are considered which makes the optimization model more detailed.

The results can also give insights to show regional added value for certain case studies where dedicating space is critical for new projects such as shopping mall with microgrids and community apartment buildings with microgrids etc. This addition of land use parameters and constraints in OptEnGrid tool can give more insights to energy system planners and certain city planning departments such as municipal authorities where space and land use is always seen as weighing parameter and constraint to make decision for new technological developments on bigger level.

6 References

- [1]. Fahy, K., Stadler, M., Pecenak, Z. K., & Kleissl, J. (2019). Input data reduction for microgrid sizing and energy cost modeling: Representative days and demand charges. *Journal of Renewable and Sustainable Energy*, 11(6), 065301.
- [2]. Duffie, John A. and Beckman, William A. *Solar engineering of thermal processes / John A. Duffie, William A. Beckman* Wiley New York 1991.
- [3]. European solar Thermal Industry Federation (ESTIF) (2007). Simple calculation of energy delivery of (small) ST systems (Report). retrieved at: <http://www.estif.org/fileadmin/estif/content/policies/downloads/SimpleCalculation.pdf>.
- [4]. Meteonorm (2021). METEOTEST AG. Meteonorm Software, <https://meteonorm.com>, zuletzt abgerufen am 28.01.2021.
- [5]. Pfenninger, Stefan and Staffell, Iain (2016). Long-term patterns of European PV output using 30 years of validated hourly reanalysis and satellite data. *Energy* 114, pp. 1251-1265. doi: 10.1016/j.energy.2016.08.060.
- [6]. Mansoor, M., Stadler, M., Zellinger, M., Lichtenegger, K., Auer, H., & Cosic, A. (2021). Optimal planning of thermal energy systems in a microgrid with seasonal storage and piecewise affine cost functions. *Energy*, 215, 119095.
- [7]. Mansoor, M., Stadler, M., Auer, H., & Zellinger, M. (2021). Advanced optimal planning for microgrid technologies including hydrogen and mobility at a real microgrid testbed. *International Journal of Hydrogen Energy*.
- [8]. Lichtenegger, K., & Unterberger, V. (2019). Thermal Trouble: Challenges in Optimization and Evaluation of Thermal Energy Systems. IAPE'19, Oxford, United Kingdom.
- [9]. Grosse, R., Christopher, B., Stefan, W., Geyer, R., & Robbi, S. (2017). Long term (2050) projections of techno-economic performance of large-scale heating and cooling in the EU. Luxembourg: Publications Office of the European Union.
- [10]. S.A. Klein, et al. TRNSYS 18: a transient system simulation program Solar Energy Laboratory, University of Wisconsin, Madison, USA (2017) <http://sel.me.wisc.edu/trnsys>
- [11]. UNFCCC. Paris agreement. FCCC/CP/2015/L.9/Rev1. 2015. Retrieved from <http://unfccc.int/resource/docs/2015/cop21/eng/l09r01.pdf>
- [12]. VOR-persönlicher Fahrplan: <https://www.vor.at/fahrplan/fahrplanservices/persoenulicher-fahrplan/>
- [13]. Umweltbundesamt Beschreibung der Verkehrsmittel Österreich (2020). Retrieved from https://www.umweltbundesamt.at/fileadmin/site/themen/mobilitaet/daten/ekz_doku_verkehrsmittel.pdf
- [14]. Rechnen Sie mit Wasserstoff: Die Datentabelle, The Linde Group (2013). Retrieved from https://www.linde-gas.at/de/images/1007_rechnen_sie_mit_wasserstoff_v110_tcm550-169419.pdf
- [15]. Petitpas, G., & Aceves, S. M. (2018). Liquid hydrogen pump performance and durability testing through repeated cryogenic vessel filling to 700 bar. *International Journal of Hydrogen Energy*, 43(39), 18403-18420.

- [16]. Ohnewein, P., Tschopp, D., Hausner, R., Doll, W. (2020). Dynamic Collector Array Test (D-CAT). Final Report FFG Project 848766 - MeQuSo. Development of methods for quality assessment of large-scale solar thermal plants under real operating conditions. Gleisdorf, AEE INTEC.
- [17]. Koiv et. al 2010: Domestic hot water consumption in educational premises, apartment and office buildings. WSEAS Transactions on Environment and Development. Abgerufen am 15.07.2020. Verfügbar in: https://www.researchgate.net/publication/229028820_Domestic_hot_water_consumption_in_educational_premises_apartment_and_office_buildings
- [18]. Edwards, Skai; Beausoleil-Morrison, Ian; Laperrière, André. Representative hot water draw profiles at high temporal resolution for simulating the performance of solar thermal systems. Solar Energy. 2015, vol. 111, p. 47. Retrieved 20th July 2020, from: <http://www.sciencedirect.com/science/article/pii/S0038092X14005131>
- [19]. APCS (2018) Synthetische Lastprofile; zuletzt abgerufen am 24.08.2018; <https://www.apcs.at/de/clearing/technisches-clearing/lastprofile>.
- [20]. E-Control (2021): Strompreisentwicklung Österreich; https://www.e-control.at/documents/1785851/1811618/MStOeN-2020_Preise.xlsx/d2d73f26-621a-08c6-565a-d1b157584991?t=1601530634668, abgerufen am 10.02.2021
- [21]. Noah Pflugradt (2021). LoadProfileGenerator <https://www.loadprofilegenerator.de/>, abgerufen am 28.01.2021
- [22]. <https://www.ris.bka.gv.at/GeltendeFassung.wxe?Abfrage=Bundesnormen&Gesetzesnummer=20007045>
- [23]. <https://www.bmk.gv.at/recht/begutachtungsverfahren/eag.html>
- [24]. Locment, F.; Sechilariu, M. Modeling and Simulation of DC Microgrids for Electric Vehicle Charging Stations. *Energies* **2015**, *8*, 4335-4356. <https://doi.org/10.3390/en8054335>

Energy Research Program – 3rd Call

Climate and Energy Funds of the Federal Government - handled by the Austrian Research Promotion Agency (FFG)

7 Contact Details

BEST – Bioenergy and Sustainable Technologies GmbH

Location Wieselburg Land

Gewerbepark Haag 3

A-3250 Wieselburg Land

<https://www.best-research.eu/en/home>



Dr. DI Michael Stadler

Michael.stadler@best-research.eu

+43 5 02378 9425

Ing. Michael Zellinger, MSc

Michael.zelligner@best-research.eu

+43 5 02378 9432

SOLID Solar Energy Systems GmbH

Am Pfangberg 117

A-8045 Graz

<https://www.solid.at>



Bernhard Gerardts

b.gerardts@solid.at

+43 664 88334506

WoldDirect

Unternehmerzentrum 10

A-6073 Sistrans

<https://www.world-direct.at/>



Tarek Ayoub

Tarek.Ayoub@world-direct.at

43 512 564 464-365

SWL

Stadtwärme Lienz Produktions- und Vertriebs-GmbH.

Aguntstraße 54

A- 9900 Lienz

www.stadtwaerme-lienz.at



Mühlmann Thomas

thomas.muehlmann@stadtwaerme-lienz.at

+43 50607-20911